

Quick Start Guide

Ares



Caution:

This is a Class A product. In a domestic environment this product may cause radio interference in which the user may be required to take adequate measures.

Packing List



Printer

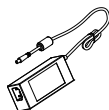

AC Adapter

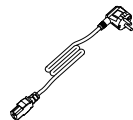

Power Cord



USB Cable

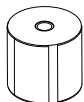

Label Roll



CD



Quick Start Guide

Note: The packing items are actually based on the order.

Appearance and Components

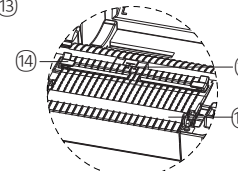
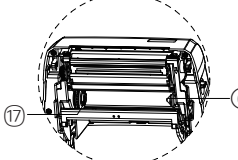
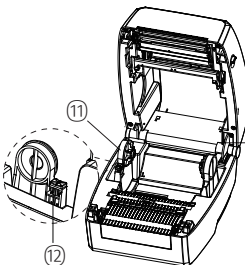
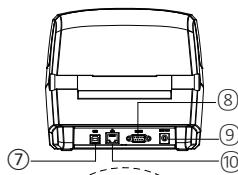
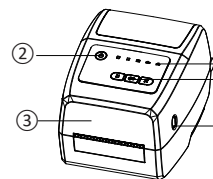

- ① Indicator Lights
- ② Power Button
- ③ Printer Cover
- ④ Feed Button
- ⑤ Cover Open Levers
- ⑥ Ribbon Supply Pin
- ⑦ USB Port (Type B)
- ⑧ Serial Port
- ⑨ Power Receptacle
- ⑩ Ethernet Port
- ⑪ Moveable Roll Holders
- ⑫ Locking Tab
- ⑬ Kick-stand Cover Lock
- ⑭ Moveable Label Guides
- ⑮ Label Sensor
- ⑯ Platen
- ⑰ Ribbon Supply Wheel

Note: The interface shown in the figure above is for reference only.

FCC WARNING:

This device complies with part 15 of the FCC Rules. Operation is subject to the following two conditions: (1) this device may not cause harmful interference, and (2) this device must accept any interference received, including interference that may cause undesired operation.

Any changes or modifications not expressly approved by the party responsible for compliance could void the user's authority to operate the equipment.

NOTE: This equipment has been tested and found to comply with the limits for a Class A digital device, pursuant to part 15 of the FCC Rules. These limits are designed to provide reasonable protection against harmful interference when the equipment is operated in a commercial environment. This equipment generates, uses, and can radiate radio frequency energy and, if not installed and used in accordance with the instruction manual, may cause harmful interference to radio communications. Operation of this equipment in a residential area is likely to cause harmful interference in which case the user will be required to correct the interference at his own expense.

- Reorient or relocate the receiving antenna.
- Increase the separation between the equipment and receiver.
- Connect the equipment into an outlet on a circuit different from that to which the receiver is connected.
- Consult the dealer or an experienced radio/TV technician for help.

To maintain compliance with FCC's RF Exposure guidelines, This equipment should be installed and operated with minimum distance between 20cm the radiator your body: Use only the supplied antenna.

Paper Loading

1. Pull and lift the cover.
2. Pull the roll holders open and place the roll between them, then press down the locking tab.

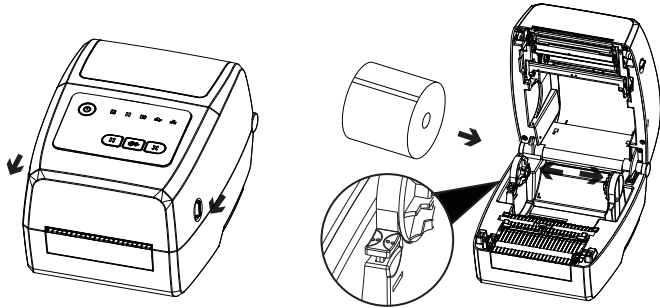

3. Pass the labels through label guides and adjust label guides to adapt to the label width.

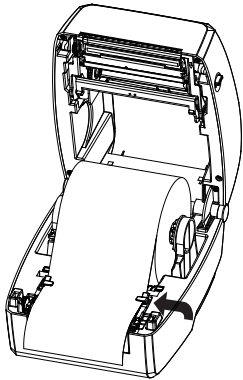

Ribbon Loading

1. Insert the right part of supply spindle, then the left part.

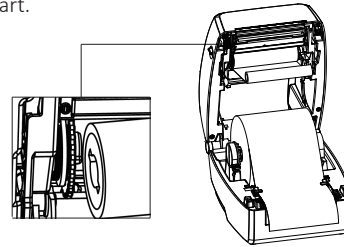

2. Press and release the print head module.

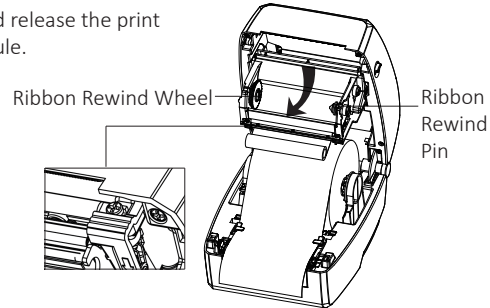

3. Insert the right part of rewind spindle and then the left part.

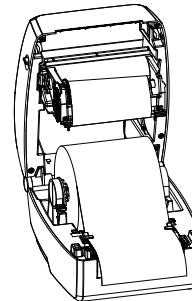

4. Rotate the ribbon rewind wheel until ribbon is pulled tightly.

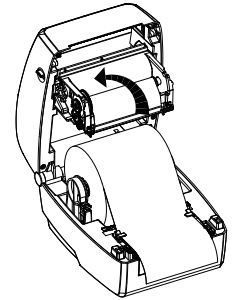

5. Close the printhead module. Then press the lock and close the cover slightly.

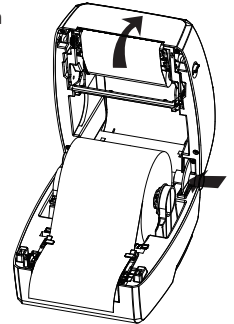

6. Press down the cover until it snaps closed.



⚠ Note: Please refer to windows driver installation in Ares User Manual.