

HPRT

Glory-L

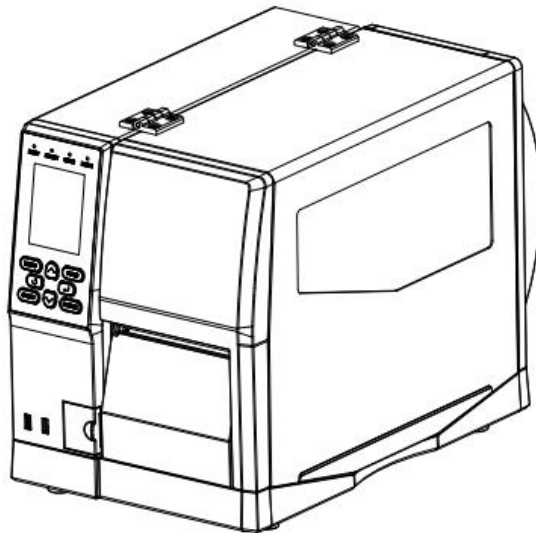

User Manual

Xiamen Hanin Electronic Technology Co., Ltd.

ADD: No.96, Rongyuan Road, Tong'an District, Xiamen, China 361100

WEB: www.hpert.com

Rev.1.0

Contents

Important Safety Instructions	1
Chapter 1 Introduction	5
1.1 Packing List	5
1.2 Appearance and Components	6
1.3 Dimension	8
Chapter 2 Specifications	9
Chapter 3 Installation & Usage	12
3.1 Ribbon and Paper Loading	12
3.1.1 Ribbon loading	12
3.1.2 Media Loading	14
3.1.3 Media Path	17
3.2 Power Connection	19
3.3 Peripherals Connection	20
3.4 Operation Panel	21
3.4.1 Panel Introduction	21
3.4.2 Button Function Definition	23
3.4.3 Buzzer	24
3.4.4 Indicator Definition	25
3.5 Display Operation Procedure	26
Chapter 4 Interface	29
4.1 USB Interface	29
4.2 Other Optional Interfaces	30
Chapter 5 Maintenance & Adjustment	32
5.1 Cleaning Media Sensor	32
5.2 Cleaning Thermal Print Head	32
5.3 Cleaning Roller and/or Paper Path	33

Chapter 6 Printer Utility Tool Instructions	34
6.1 Installation Preparation	34
6.2 Usage	34
Chapter 7 Seagull Windows Driver Instructions	50
7.1 Introduction	50
7.2 Installation Preparation	50
7.3 Installation	51
7.4 Usage	57
7.4.1 Printing Preferences	57
7.4.2 Printer Properties	68
7.5 Removing	72
Chapter 8 BarTender UltraLite Instructions	77
8.1 Introduction	77
8.2 Installation Preparation	77
8.3 Installation	78
8.4 Usage	82
8.4.1 Page Settings	82
8.4.2 label Edit	91
Appendix I Display Menu	96
Appendix II Warning	103
Appendix III Icon Description	106
Appendix IV Trouble Shooting	108
Appendix V Download Path for Utility and Driver	111

Change Record

Rev.	Date	Description	Editor	Checker
1.0		--		



■ Statement

This manual content may be altered without permission, and our company reserves the rights to make changes without notice in technology, spare parts, hardware and software of the products. If more information is needed about the products, please contact our company. Without any written permission from our company, any section of this manual is prohibited to be copied or transferred in any form.

■ Copyright

This manual is printed in 2023, the copyright belongs to Xiamen Hanin Electronic Technology Co. Ltd.

Printed in China

1.0 Version

■ Warnings



This must be complied with in order to avoid any damage to the human body and the equipment.



This is showing the important information and tips for the printer operation.



Note: Due to continuous update of our product, the description of printer specification, accessories, design in this manual may be slightly different. Please keep in kind prevail.

Important Safety Instructions

Before using the appliance, please carefully read the following safety regulations in order to prevent any hazard or material damage.

1. Safety warning



Warnings: The print head will become very hot during printing. avoid contact with the print head after printing has finished.



Warnings: Do not touch the printer head and connector in case static damage the printer head.

2. Instructions



Warnings: Violating following instructions can cause serious injury or death.

1) Do not plug several products in one multiperture outlet.

- This can provoke over-heating and a fire.
- If the plug is wet or dirty, dry or wipe it before usage.
- If the plug does not fit perfectly with the outlet, do not plug in.
- Be sure to use only standardized multiperture outlet.

2) You must use the supplied adapter.

- It is dangerous to use other adapters.

3) Do not pull the cable to unplug.

- This can damage the cable, which is the origin of a fire or a breakdown of the printer.

4) Do not plug in or unplug with your wet hands.

- You can be electrocuted.

5) Do not bend the cable by force or leave it under any heavy object.

- A damaged cable can cause a fire.



Note: Violating following instructions may cause slight damage of the appliance.

- 1) If you observe a strange smoke, odour or noise from the printer, unplug it before taking following measures.
 - Switch off the printer and unplug the set from the mains.
 - After the disappearance of the smoke, call your dealer to repair it.
- 2) Install the printer on the stable surface.
 - If the printer falls, it can be broken and you can hurt yourself.
- 3) Use the approved accessories only and do not try to disassemble, repair or remodel it by yourself.
 - Call your dealer when you need these services.
 - Do not touch the blade of auto cutter.
- 4) Do not let water or other foreign objects drop into the printer.
 - If this happened, switch off and unplug the printer before calling your dealer.
- 5) Do not use the printer when it is out of order. This can cause a fire or an electrocution.
 - Switch off and unplug the printer before calling your dealer.
- 6) Other considerations:
 - Place the printer on a solid and even base so that it cannot fall.
 - Leave enough space around printer for operation and maintenance.
 - Keep all liquids away from the printer.
 - Do not expose the printer to high temperatures, direct sunlight or dust.
 - Ensure the printer is connected to a socket with the correct mains voltage.
 - Switch off the printer POWER supply when it's not in use for a long time.
 - To ensure the printing quality and reliability, suggest use the same quality or recommend paper supplier.
 - Pls. switch off the POWER supply when connect/disconnect all the ports or it will cause damage to the printer control circuit.
 - Never carry out maintenance or repair work yourself. Always contact a qualified service Technician.
 - Keep this User Manual in a place which is easily accessible for all times.

3. Other Precautions

The copyright for this user manual and various other manuals is property of our company. Any copying or conversion into electronic form and saving of this material without the express written permission is strictly prohibited. Use of the information contained in this manual is not subject to any patent liability. This manual has been prepared with utmost care and attention to detail but may contain certain errors and/or omissions. Our company is not legally liable for any damages resulting from the use of the information in this manual. Our company and its affiliates are not legally liable (United States excluded) for any damages, loss, costs, and/or expenses that result from the breakdown, malfunction, and/or misuse of the product due to violation or neglect of the operation and maintenance information and instructions provided by our company, as well as from the unauthorized alteration, repair, and/or modification of the product by the user and/or third party. We are not legally liable for any damages and/or issues resulting from the use of options and/or parts that are not authentic or authorized products.

4. WEEE (Waste Electrical and Electric Equipment)



This mark shown on the product or its literature indicates that the corresponding item should not be discarded at the end of its working life with others household waste. To prevent possible harm to the environment or human health from uncontrolled waste disposal, please separate marked items from other types of waste and recycle them responsibly to promote the sustained reuse of material resources. Household users should contact either the retailer where they purchased this product, or their local government office for details of where and how they can conduct environmentally safe recycling of such items. Commercial users should contact their suppliers and check the terms and conditions of purchase contracts. This product should not be combined with other commercial waste for disposal.



Caution: This is a Class A product. In a domestic environment this product may cause radio interference in which the user may be required to take adequate measures.

5. FCC WARNING

This device complies with part 15 of the FCC Rules. Operation is subject to the following two conditions: (1) this device may not cause harmful interference, and (2) this device must accept any interference received, including interference that may cause undesired operation.

Any changes or modifications not expressly approved by the party responsible for compliance could void the user's authority to operate the equipment.

NOTE: This equipment has been tested and found to comply with the limits for a Class A digital device, pursuant to part 15 of the FCC Rules. These limits are designed to provide reasonable protection against harmful interference when the equipment is operated in a commercial environment. This equipment generates, uses, and can radiate radio frequency energy and, if not installed and used in accordance with the instruction manual, may cause harmful interference to radio communications. Operation of this equipment in a residential area is likely to cause harmful interference in which case the user will be required to correct the interference at his own expense.

- Reorient or relocate the receiving antenna.
- Increase the separation between the equipment and receiver.
- Connect the equipment into an outlet on a circuit different from that to which the receiver is connected.
- Consult the dealer or an experienced radio/TV technician for help.

To maintain compliance with FCC's RF Exposure guidelines, This equipment should be installed and operated with minimum distance between 20cm the radiator your body: Use only the supplied antenna.

Chapter 1 Introduction

1.1 Packing List

1. Unpack the printer and keep the packing material in case you need to ship the printer in the future.
2. Any damages exist, please contact the local dealer.



Printer



Power Cord



USB Cable



Quick Start Guide



Note: The packing materials are based on the order.

1.2 Appearance and Components

■ Front View

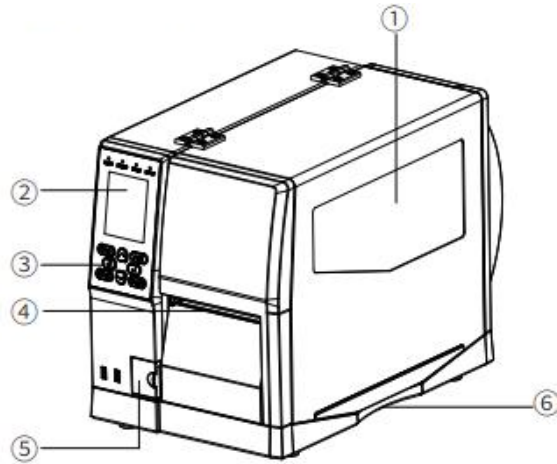

- ① Cover Assembly
- ② Display
- ③ Control Panel
- ④ Exit Slot
- ⑤ Cover of Extend Ports
- ⑥ Cover Opening

■ Rear View

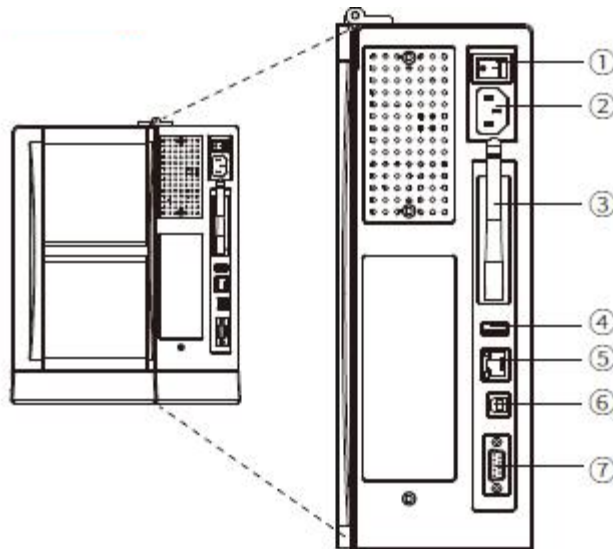

- ① Power Switch
- ② AC Power Port
- ③ Wi-Fi Antenna
- ④ USB Host
- ⑤ Ethernet Port
- ⑥ USB B-type
- ⑦ Serial Port

■ Inside View

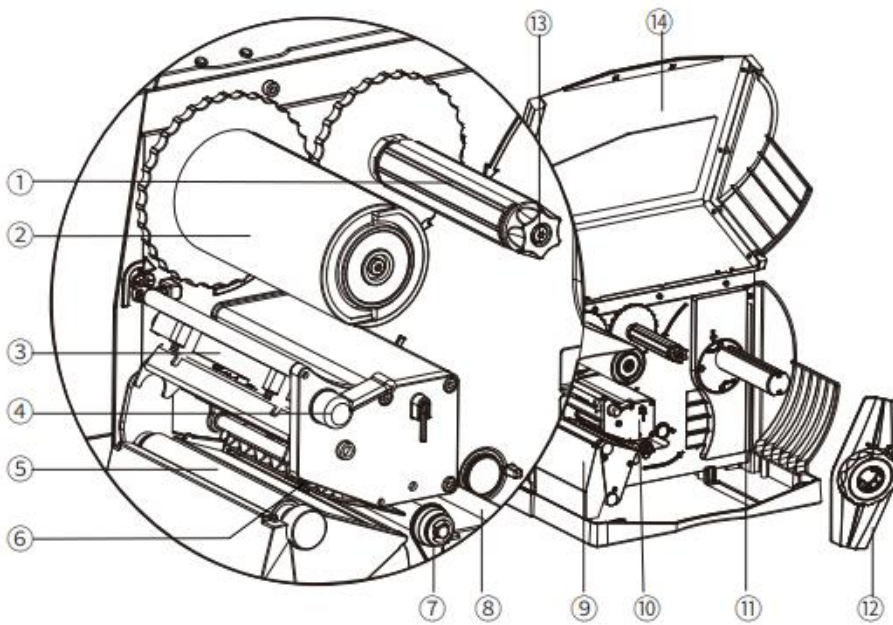

- ① Ribbon Supply Spindle
- ② Ribbon Take-up Spindle
- ③ Print Head Module
- ④ Print Head Lever
- ⑤ Platen Roller
- ⑥ Media Sensor
- ⑦ Paper Guide
- ⑧ External Media Guide
- ⑨ Filler Block
- ⑩ Print Mechanism
- ⑪ Media Supply Spindle
- ⑫ Media Supply Guide
- ⑬ Ribbon Latch
- ⑭ Side Cover



Note: The views above are for your reference. Ports vary by your choice.

1.3 Dimension

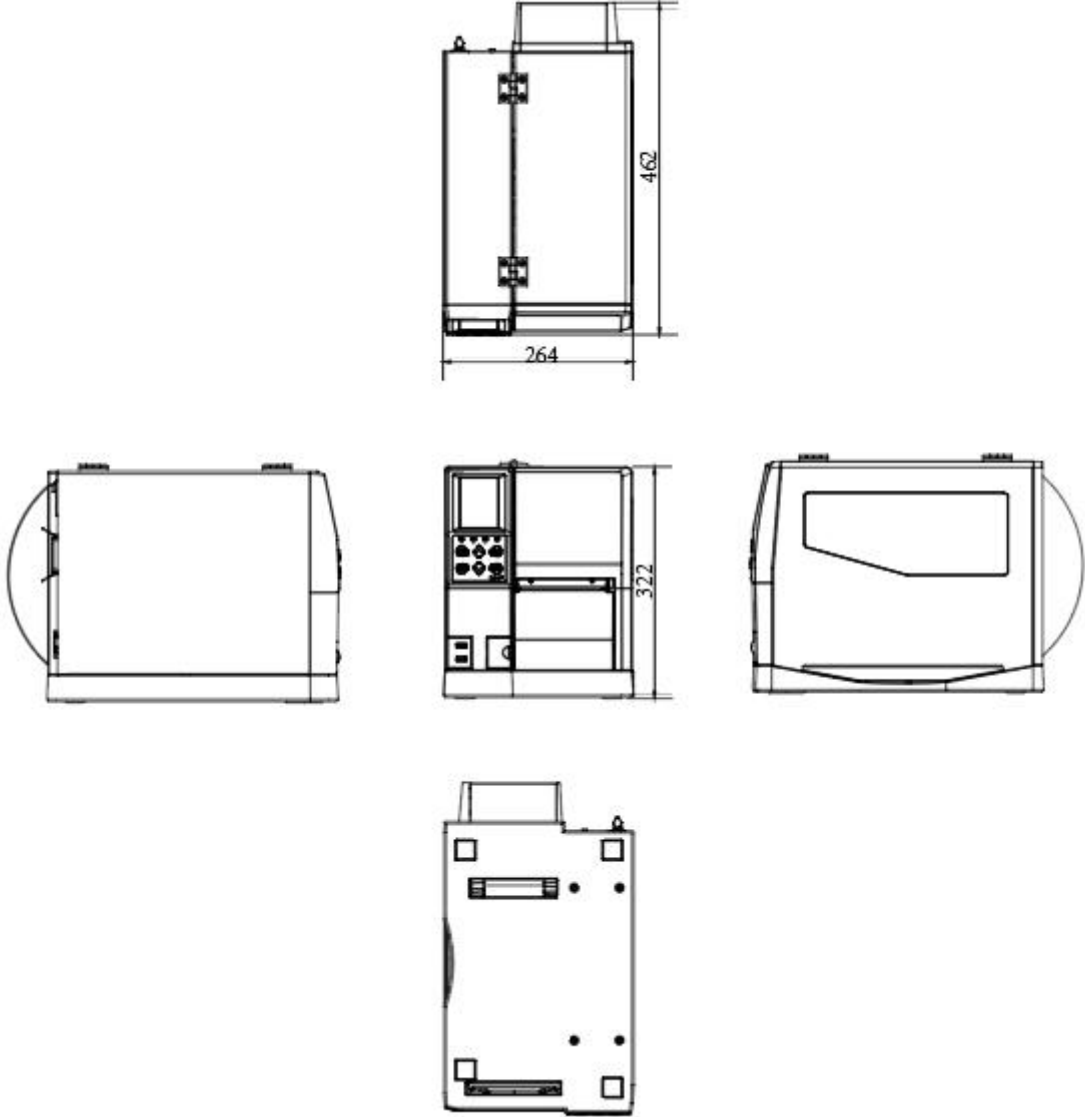

Chapter 2 Specifications

Item		Parameter
Printing	Printing Method	Printing
	Resolution	203dpi/300dpi
	Printing Speed	2~6ips
	Printing Width	104mm
	Printing Length	2286mm(203dpi)/1524mm(300dpi)
CPU		32-bit RISC CPU
Memory	RAM	32MB
	Flash	128MB
Detection	Sensor	Paper Out Detect, Seam Mark Detect, Black Mark Detect, TPH Over, Cover-opened Detect
Media	Type	Fold Paper, Roll Paper, Continuous Paper, Black Mark
	Width	25mm~200mm
	Thickness	0.003-inch (80um) – 0.010-inch (250um)
	Label Outer Diameter	10-inch (254mm)
	Label Inside Diameter	1.5-inch (38.1mm), 3-inch (76.2mm)
Ribbon	Type	Wax, Wax/Resin, Resin
	Width	1.18-inch(30mm) – 4.33-inch(110mm)
	Length	1476' (450 m)
	Inside Diameter	1-inch (25.4mm)

Programming Language		DPL, EPL2, ZPL-II
Software	Label Design Software	Seagull Bartender UltraLite
	Driver	Windows XP, 7, 8, 10. server 2008, 2012 CUPS for Linux and MAC OS
Resident Fonts	Bitmap fonts	6, 8, 12, 16, 32, OCR A & B. 90°, 180°, 270° rotatable and 10 times expandable in horizontal and vertical directions
	TTF fonts	Monotype CG Triumvirate™.
Download Fonts	Bitmap fonts	90°, 180°, 270° rotatable and 10 times expandable in horizontal and vertical directions
	TTF fonts	90°, 180°, 270° rotatable
	Asian fonts	16x16, 24x24. Traditional Chinese, Simplified Chinese, Japanese, Korean
Code Pages		DOS437,720,737,755,775,850,852,855,856,857,858,860,862,863,864,865,866, Windows 1250,1251,1252,1253,1254,1255,1256,1257,1258 ISO8859-1,-2,-3,-4,-5,-6,-8,-9,-15 DBCS 932 (JIS), 936(GBK), 949 (Koran), 950(BIG5)
Barcodes	1D	Code 39, Code 93, EAN 8/13 (add on 2 & 5), UPC A/E (add on 2 & 5), I 2 of 5 & I 2 of 5 with Shipping Bearer Bars, Codabar, Code 128 (subset A, B, C), EAN 128, RPS 128, UCC 128, UCC/EAN-128 K-Mart, Random Weight, Post NET, ITF 14, China Postal Code, HIBC, MSI, Plessey, Telepen, FIM, GS1 DataBar, German Post Code, Planet 11 & 13 digit, Japanese Postnet, I 2 of 5 with human readable check digit, Standard 2 of 5, Industrial 2 of 5, Logmars, Code 11, Code 49, Cadablock

Barcodes	2D	PDF417, Data matrix code, Maxi Code, QR code, Micro PDF417, Micro QR code, Aztec code
Interfaces	Standard	USB, USB HOST, RS232, Ethernet
	Optional	Wi-Fi
LCD Display		3.5" TFT LCD
RTC Function		Support
Control Panel		Status light, Prompt light, Error light, Power light Control button: Menu, Calibration, Feed, Pause, Return, Enter, Up/Down Arrow
Power Supply		Input: AC 100V-240V, 50/60Hz Output: DC 24V/2.5A
Environment	Operation	41-104°C @ humidity 30% to 85%, non-condensing
	Storage	-20°C-50°C @ humidity 10% to 90%, non-condensing
Physical	Dimension	462*264*322mm (L*H*W)
Characteristic	Weight	12.5 Kg
Options & Accessory		Peeler Module, Cutter Module, External Label Roll Holder
Agency Approval		CCC, FCC, CE, CB, UL, RoHS, WEEE

Chapter 3 Installation & Usage

3.1 Ribbon and Paper Loading

3.1.1 Ribbon loading

1. Place the printer on the flat table, lift the cover from the bottom-right of printer by hands.

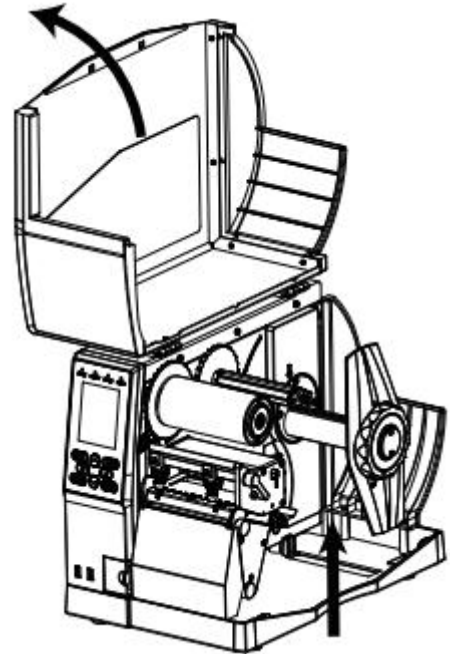

2. Load the outside ink ribbon into ribbon supply spindle, then anticlockwise tighten the latch knob to fix the ribbon.

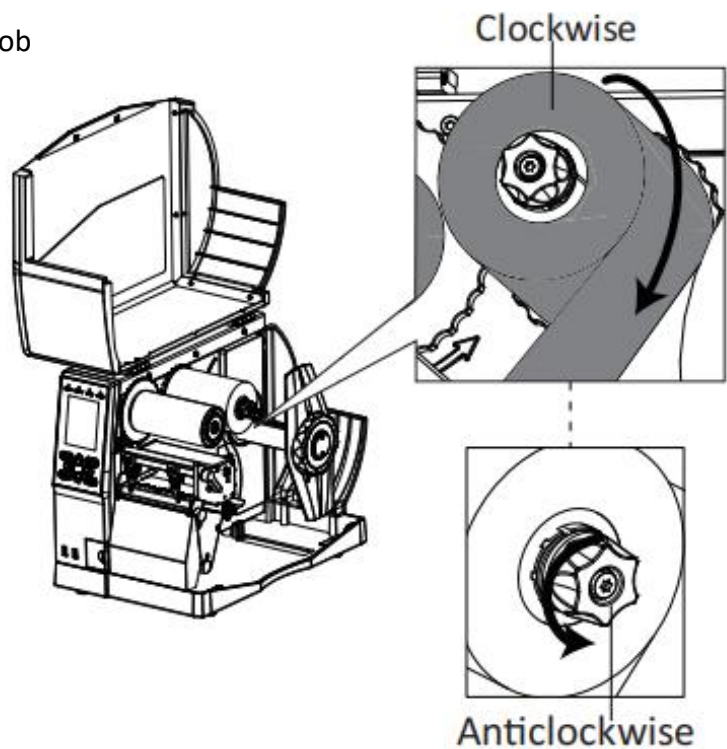

3. Pull a part of ribbon, then pass the ribbon between the print mechanism and the media sensor.

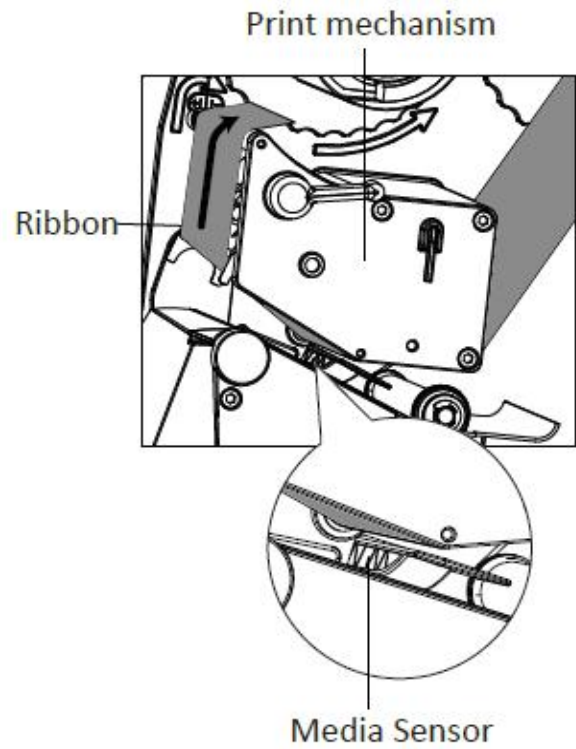

4. Pass the ribbon over the print mechanism and the ribbon take-up spindle, and then wrap it several turns around the ribbon take-up spindle.

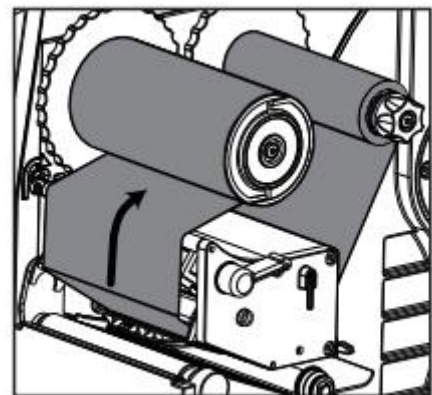

Ribbon Take-up Spindle

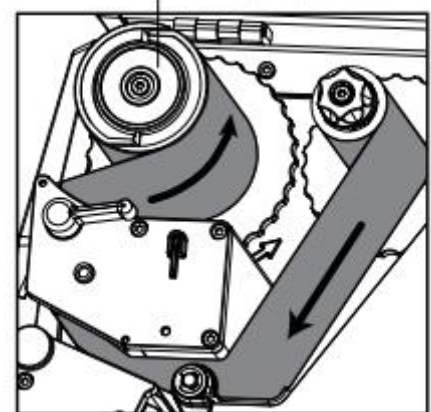

3.1.2 Media Loading

1. Rotate the arrow mark that locates in media guide lock of media spindle to unlocking position, then remove the media guide.

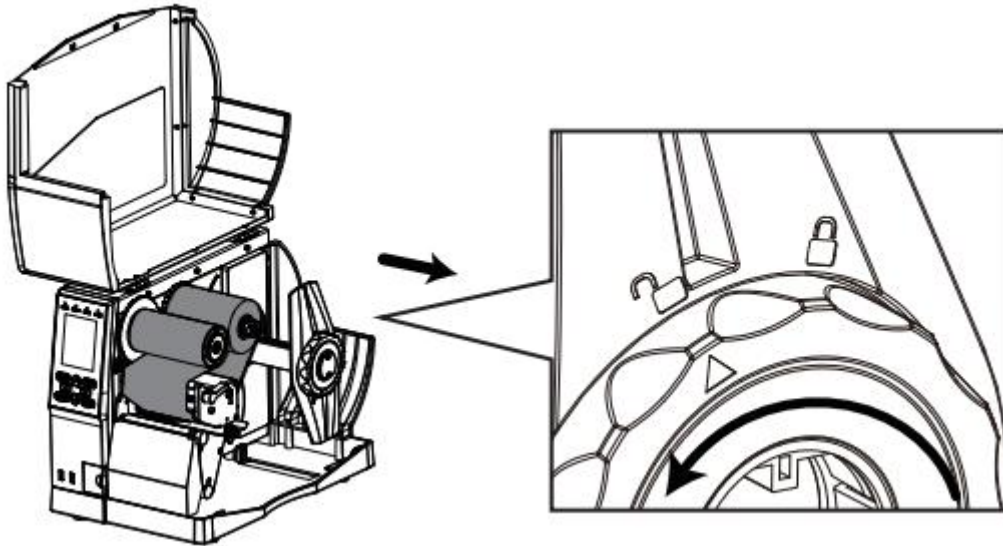

2. Mount a label roll onto the media spindle. Be sure to push the roll all the way aligned the inner wall of the printer. After the label roll be loaded, put the media guide back on the media spindle. Then rotate the arrow mark that locates in unlocking position to lock position so that it can be latched.

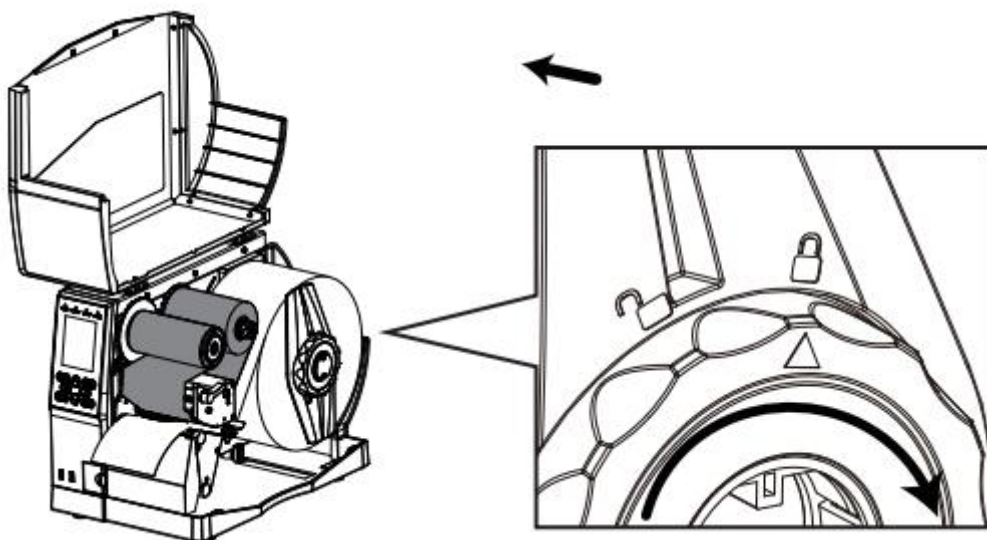

3. Pull out part of label and pass it under the media dancer assembly and media sensor until it reaches the exit slot. Then slide the paper guide apart to adjust for the label width.

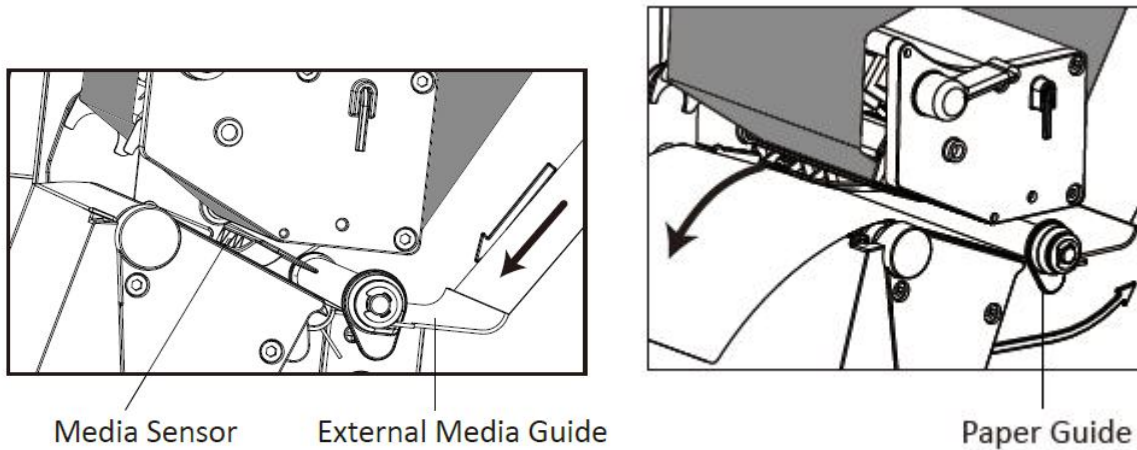

4. When using the gap label, black mark label or punch hole label, you can manually adjust the media sensor by the pulling to find the gap, black mark or punch hole for the start printing position.

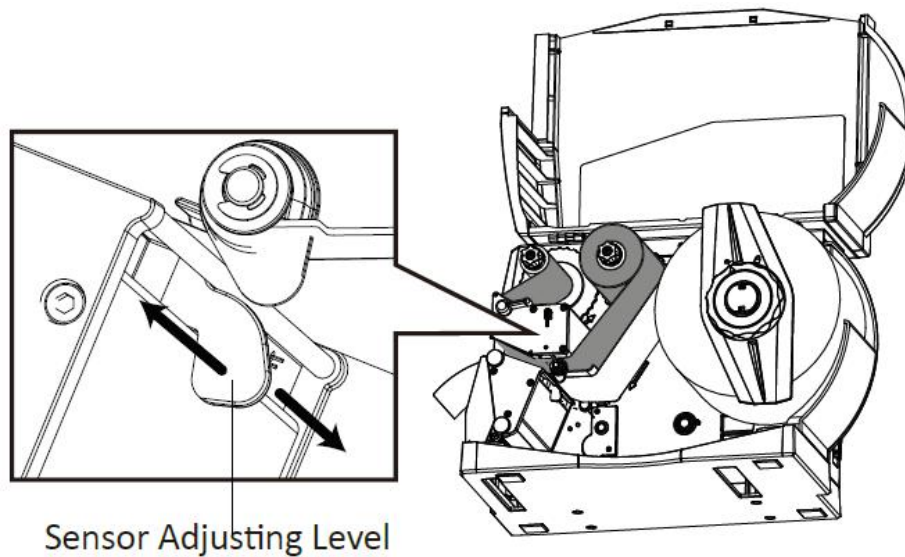

5. After finishing the label loading, turn down the print head lever to make ribbon and label fit snugly.

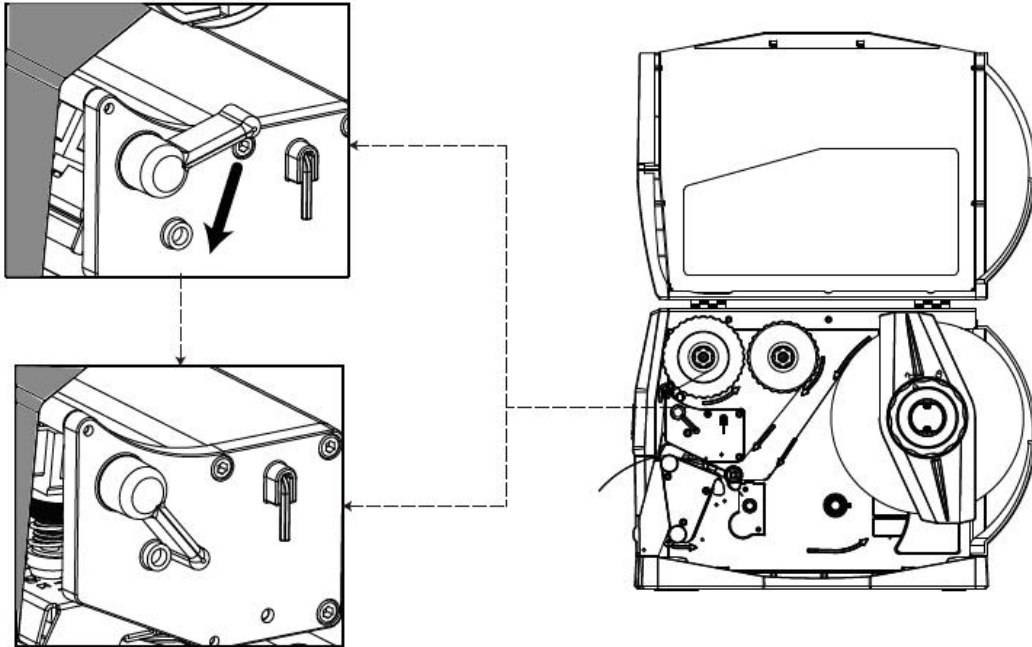

3.1.3 Media Path

1. Backside feeding

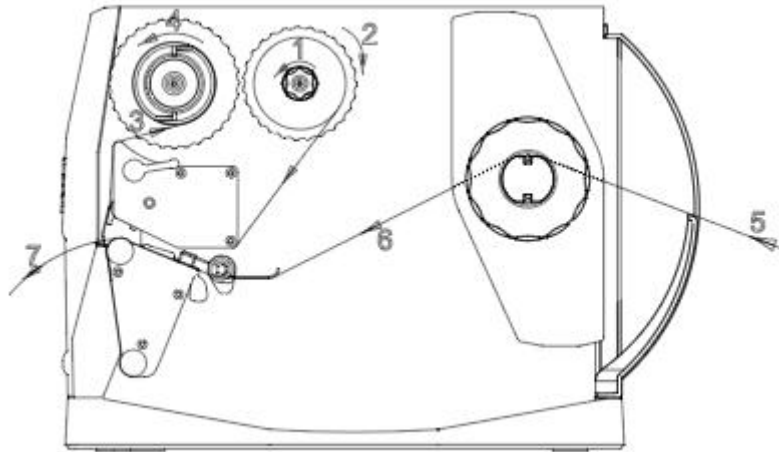

2. Bottom feeding

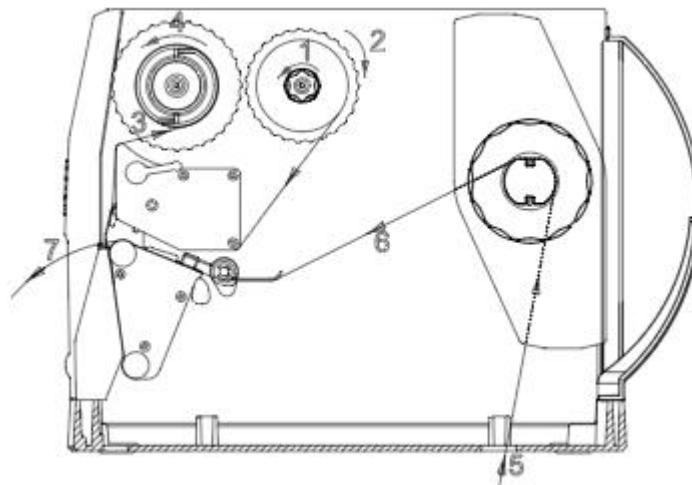

3. Installation of direct throwing peeler

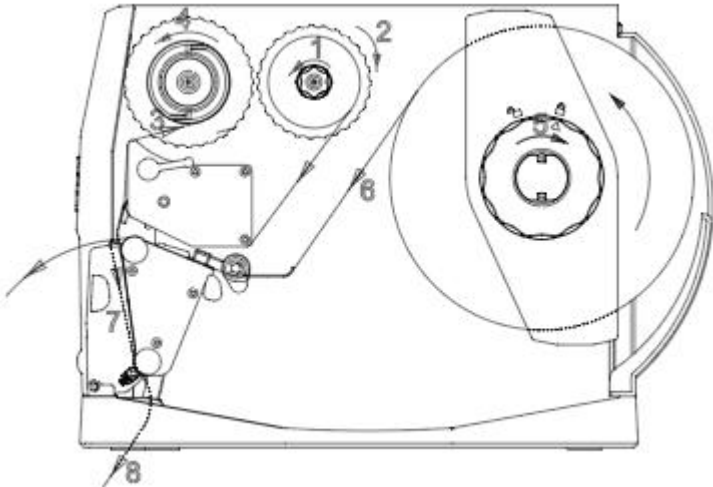

4. Installation of rollback peeler

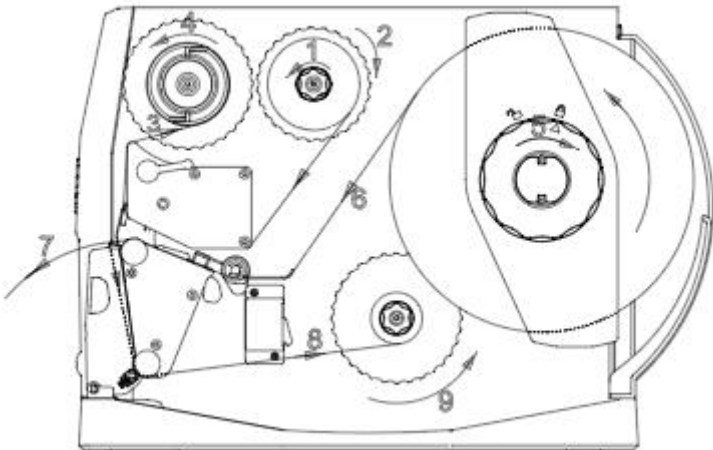

3.2 Power Connection

1. Connect the power plug to power receptacle.
2. Connect the other end of power cord to the AC power port.

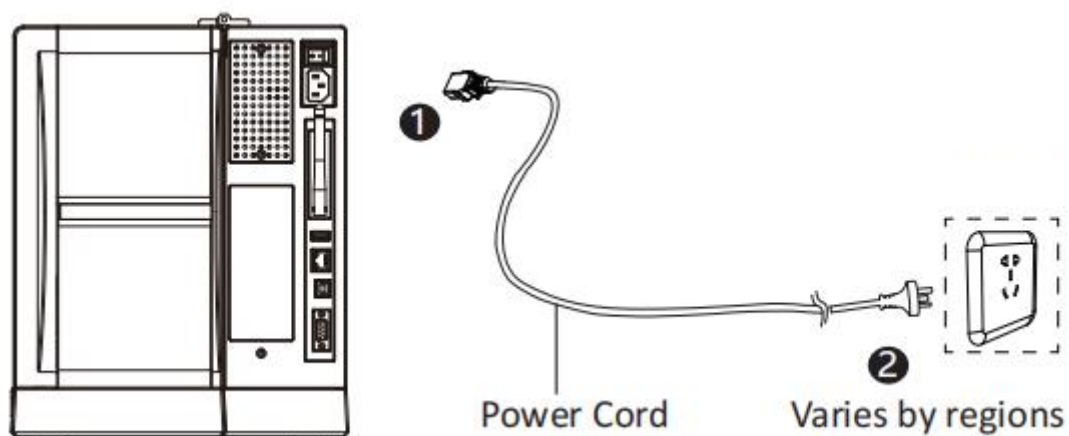

Caution:

- Use the original power adapter only. Avoid the damage caused by charging improperly.
- Please unplug the printer power cord if it is not in use for a long time.

3.3 Peripherals Connection

When printing paper, the moveable label sensor is used to detect paper. The label sensor moves differently when using various kinds of paper. If user moves the sensor improperly, paper may not be detected, therefore the printer could not print paper. The following instructions tell users how to use label sensor correctly. Please read it carefully.

When printing, the sensor shall be aimed at the triangle below, which is the original position.

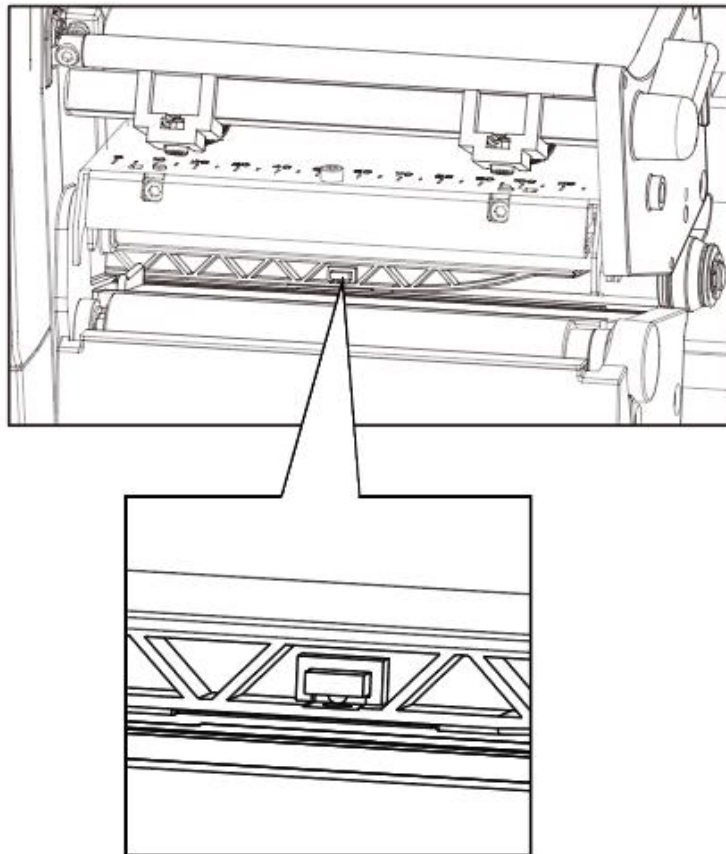

3.4 Operation Panel

3.4.1 Panel Introduction

The panel indicates the printer's operating status and allows the user to control basic printer operation.

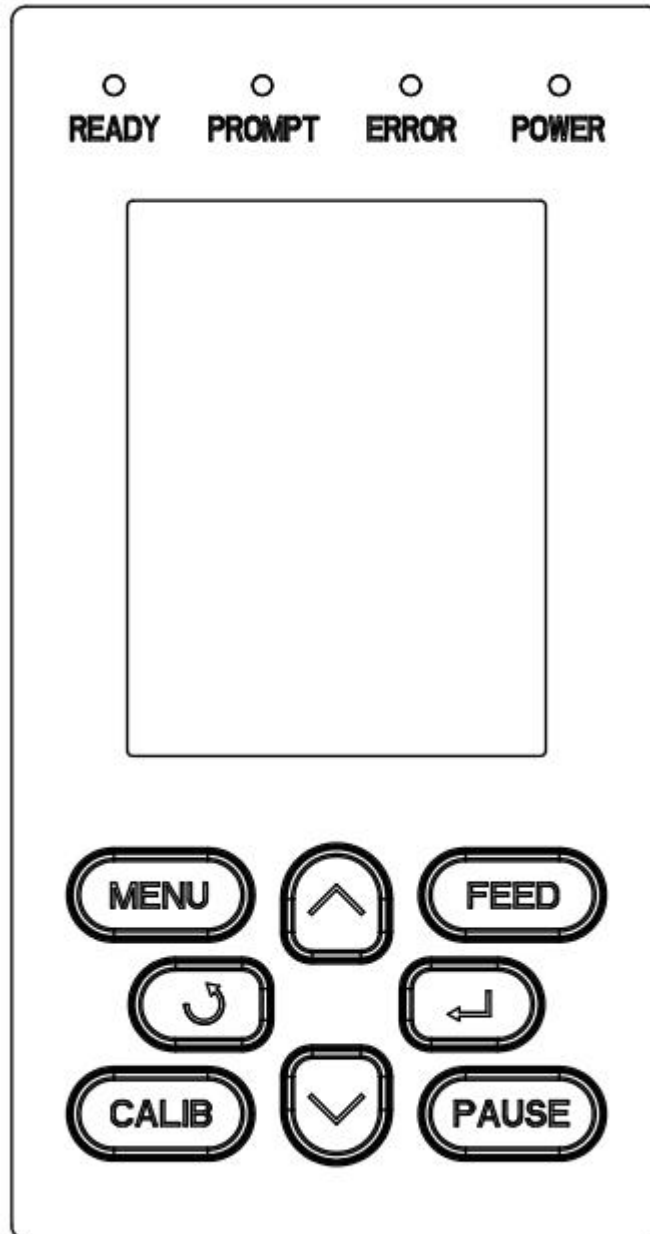

1.Feed Button



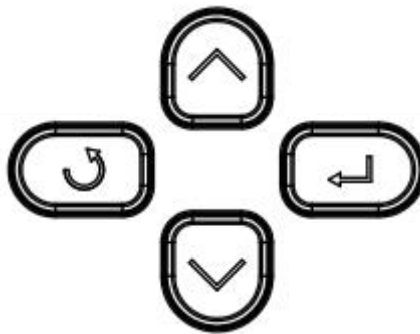

Much more detailed information is provided in "3.6.1 FEED Button".

2.Directionals Pad (only for printer Bravo-L)

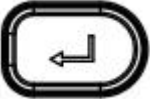

It is included by up arrow button, down arrow button, return button and enter button.

-  Up Arrow Button: Common uses are to scroll through choices, navigating to the left or the previous choice.
-  Down Arrow Button: Common uses are to scroll through choices, navigating to the right or the next choice.
-  Return Button: Back to previous.
-  Enter Button: Common uses are to navigate to the sub-menus, change the values or to save the settings.

3.4.2 Button Function Definition

1. Menu button: in standby state, long press the menu operation function to enter the display
2. Calibration button: in standby state or the error light slow flash, long press the “Start label learning function”.
3. FEED button:
 - In the ready state, press the feed button (*<1 seconds*), then release the feed button. The printer will **make a blank paper positioning** according to label / black mark label. If it is continuous paper, press the feed button and the printer will continue to feed the paper. Release the paper feed button to stop printing immediately.
 - In the ready state, press the feed button (*approx. 1.5 seconds*) until the status light is green, then release the feed key. And the printer prints the **self-test page**.
 - In the ready state, press the feed button (*approx. 3 seconds*) until the status light is orange, then release the feed button. And the printer starts making a label learning of seam label.
 - In the ready state, press the feed button (*approx. 4.5 seconds*) until the status light is red, then release the feed button. And the printer starts making a label **learning of black mark label**.
 - In the ready state, press the feed button (*approx. 6 seconds*) until the green light slow flash, then release the feed button. And the printer starts getting into **dump mode of data**.
 - In dump mode state, press the feed button to print "Out of Dump Mode Now", then return to print mode.
 - Error light: red light slow flash, short press feed button, printer will position to next paper according to label / black mark label. If it is continuous paper, press the paper feed button and the printer will continue to feed the paper. Release the paper feed button to stop printing immediately.

4. Pause button:

- In Printing: short press to pause print, long press to clear current print task.
- Printing Pause: short press to keep printing, long press to clear current print task

5. Navigation button: only can be used with the display.

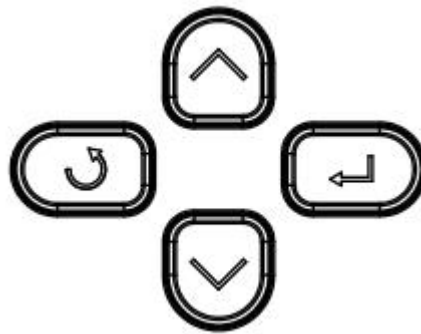

➤ **Note: short press: 0.3 seconds to 1 seconds.**

Long press: larger than 3 seconds

3.4.3 Buzzer

1. Silence: not set / normal
2. Beep 0.2 seconds: button response / touch response
3. Beep 1.5 seconds and stop 2 seconds: during printing, run out of paper / label off / paper jam

3.4.4 Indicator Definition

1. Power light:

- ✧ OFF: no power / not power on
- ✧ Green light constant bright: normal
- ✧ Green light slow flash: dump mode

2. Error light:

- ✧ OFF: not power on/ normal
- ✧ Red light constant bright: run out of paper/ print head open.
- ✧ Red light slow flash: out of ribbon
- ✧ Red light fast flash: jam paper/label off/ cutter stuck

3. Promote light:

- ✧ OFF: not power on/ normal
- ✧ Orange light constant bright: manually print (FEED button/ take paper sensor)
- ✧ Orange light slow flash: Label format mismatch
- ✧ Orange light flash: Print pause

4. Ready light:

- ✧ OFF: not power on
- ✧ Green light constant bright: printer standby
- ✧ Green light slow flash: get in dump mode
- ✧ Green light fast flash: in data reception



Note:

Quick flash → 0.2 second / every cycle

Slow flash → 1 second / every cycle

3.5 Display Operation Procedure

▲Note: The user can confirm the status of the printer via the display.

It is divided into ready display, home menu display, sub-menu displays and operating displays.

1. Make sure that the printer is connected and the roll is installed correctly.
2. Turn on the printer power. When the printer is turned on, it will display the standby interface. Under the standby interface, users can obtain information about the printer name, menu, and firmware version.

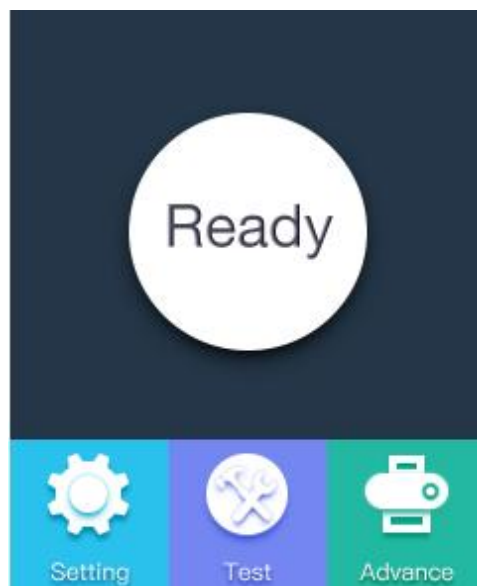

(1) Under the printer standby interface, click on the "System Settings" to enter the system settings.

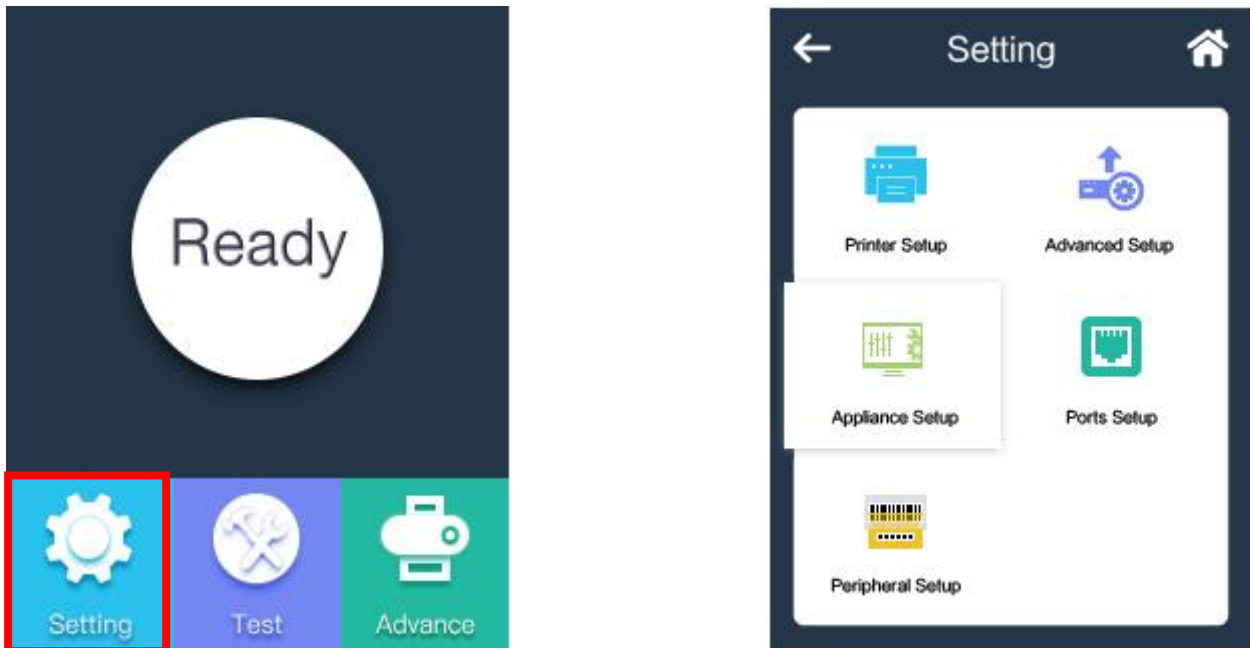

▲ Note: The individual items set up have the password lock function, once the password lock function is started, you must enter the correct password to enter the system settings. For the locked setup item, the printer automatically excludes the corresponding setup instructions from the print task.

(2) Under the printer standby interface, click on the "Test" to enter the test selection.

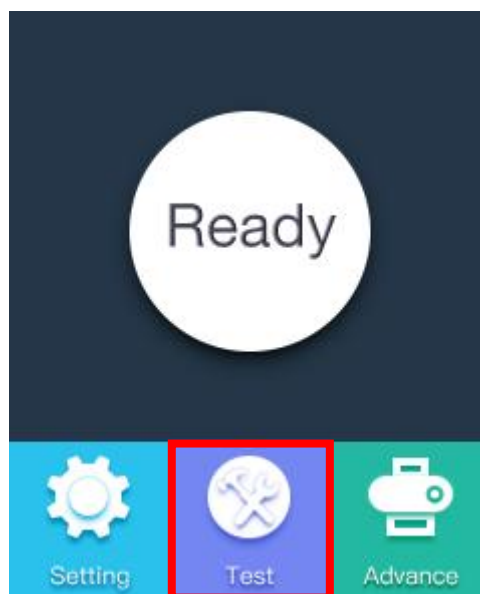

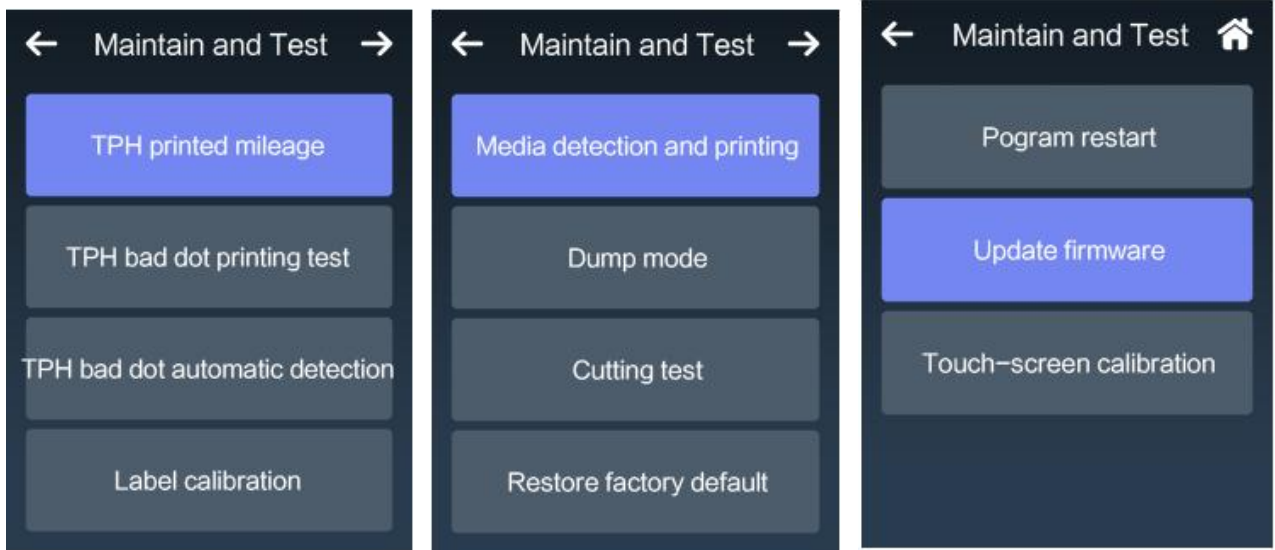

(3) Under the printer standby interface, click on the "Advance " to enter the settings.

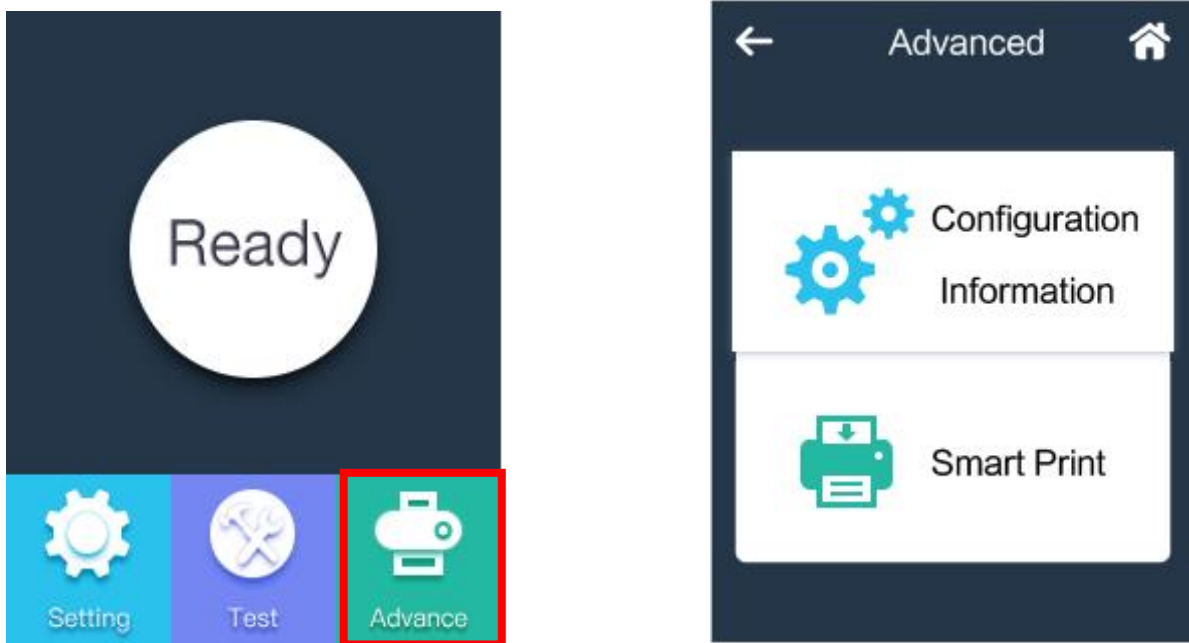

▲ Note: For more information about the display menu, please refer to the appendix.

Chapter 4 Interface

4.1 USB Interface

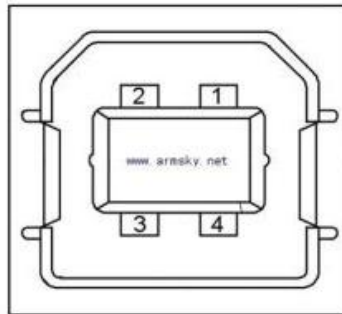

PIN	SIGNAL NAME
1	VBUS
2	D-
3	D+
4	GND

4.2 Other Optional Interfaces

■ Serial Port

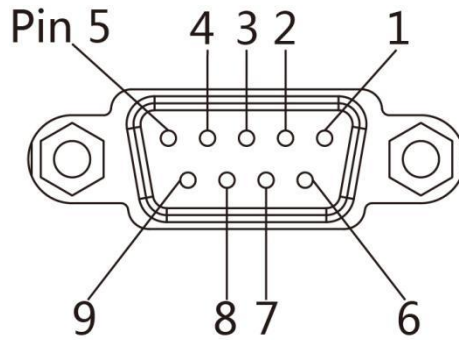

PIN	SIGNAL NAME	SIGNAL DIRECTION
1	+5VDC	OUTPUT
2	RXD	OUTPUT
3	TXD	INPUT
4	DTR	INPUT
5	GND	GROUNDING
6	DSR	OUTPUT
7	RTS	INPUT
8	CTS	OUTPUT
9	-	NO CONTACT

■ Ethernet Port

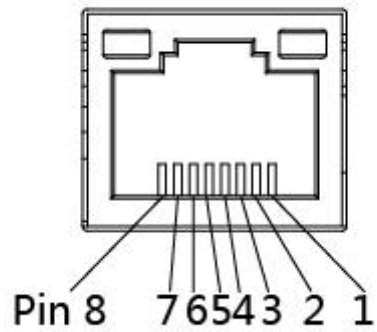

PIN	SIGNAL NAME
1	TX+
2	TX-
3	RX+
4	-
5	-
6	RX-
7	-
8	-

Chapter 5 Maintenance & Adjustment

Adhesives and coatings of the media can transfer to the printer parts over time along the media path including the thermal print head and media sensor. This build-up can accumulate dust and debris. Failure to clean the print head, media path, and media sensor could result in inadvertent loss of labels, label jams and possible damage to the printer.



Note:

- Make sure to turn off the printer prior to cleaning.
- As the print head gets hot during printing, if intending to clean the print head, turn the printer off and wait approximately 2~3 minute before commencement.
- When cleaning the print head, take care not to touch the heated portion of the print head. Print Head is susceptible to damage from static electricity, etc. It is strongly recommended to wear hand gloves during cleaning progress.
- Take care not to allow the print head become scratched and/or damaged in any way.

5.1 Cleaning Media Sensor

Debris or dirt on the paper sensor can cause a miss-read or unstable detection of the label gap. Clean with a cotton bud dampened with alcohol.

5.2 Cleaning Thermal Print Head

Thermal Paper stock on the print head, which degrades print quality. Clean the print head with methanol or isopropyl alcohol and a cotton bud. Do not touch the heating elements with your fingers.

- 1) Open the Printer Cover and then use the cleaning pen to clean the head in the direction from the center of the head to two sides.
- 2) After cleaning the head, do not use the printer until the alcohol used for cleaning evaporates completely (1~2 min) and the printer has completely dried.
- 3) Perform the cleaning process each time the paper roll is replaced to prevent print quality

deterioration.

5.3 Cleaning Roller and/or Paper Path

- 1) Open the printer cover and then remove the paper.
- 2) Remove any dust or foreign substance using dry cloth or cotton swab.
- 3) Soak the cloth or cotton swab in alcohol for medical use and use it to remove adhesive foreign substances or other pollution materials.
- 4) After cleaning the parts, do not use the printer until the alcohol evaporates completely (1~2 min) and the printer has completely dried



Note: Clean the parts when print's quality or label detection degrades.

Chapter 6 Printer Utility Tool Instructions

6.1 Installation Preparation

Download application program HPRTPrinterUtility.exe in CD.

6.2 Usage



Note: The screen may vary slightly by different operating systems and models. .

1. Install "HPRTPrinterUtility.exe", then open it.

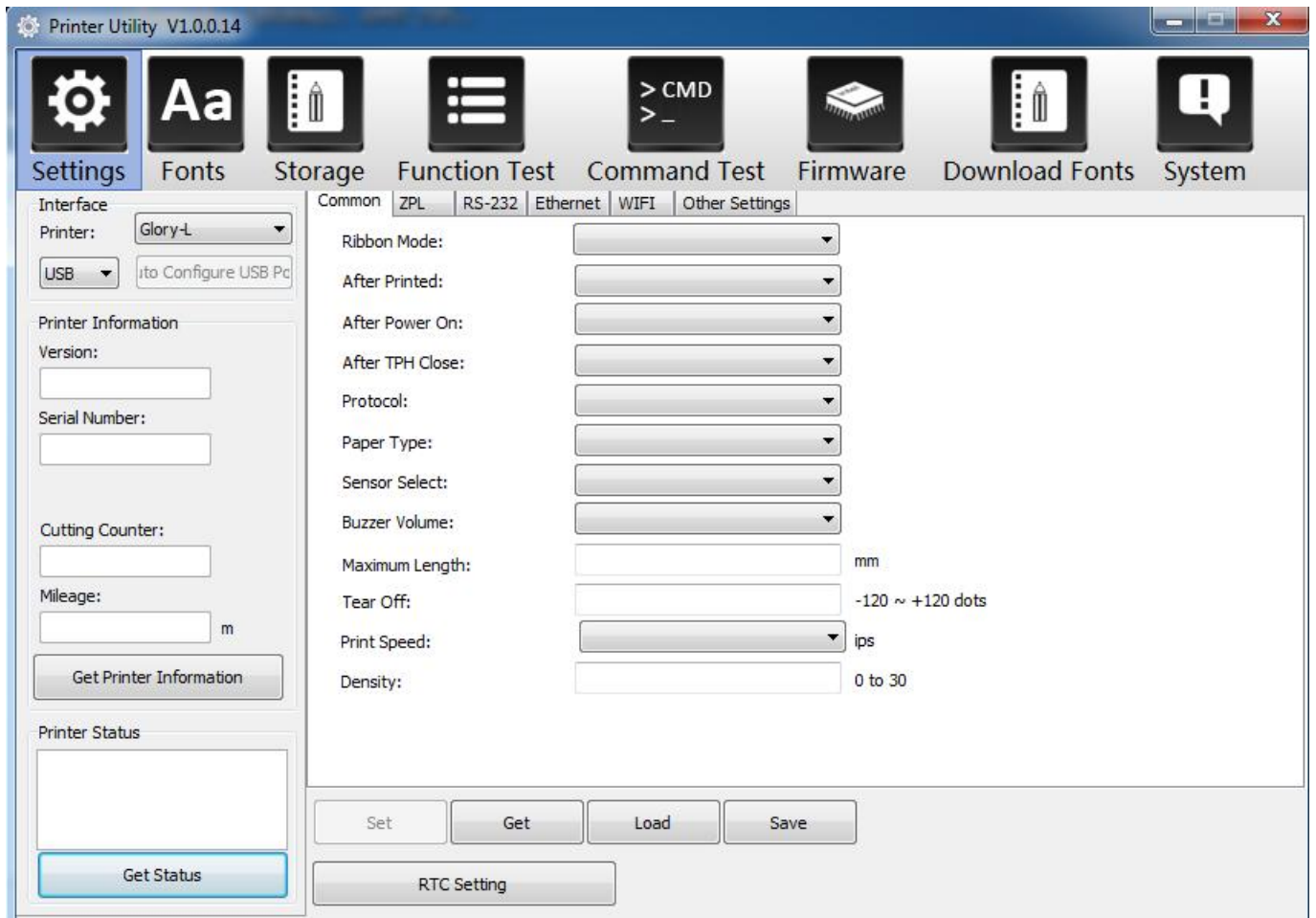

2. Click "Settings".

(1) Set up the interface needed. (range: USB, COM, LPT, ETH)

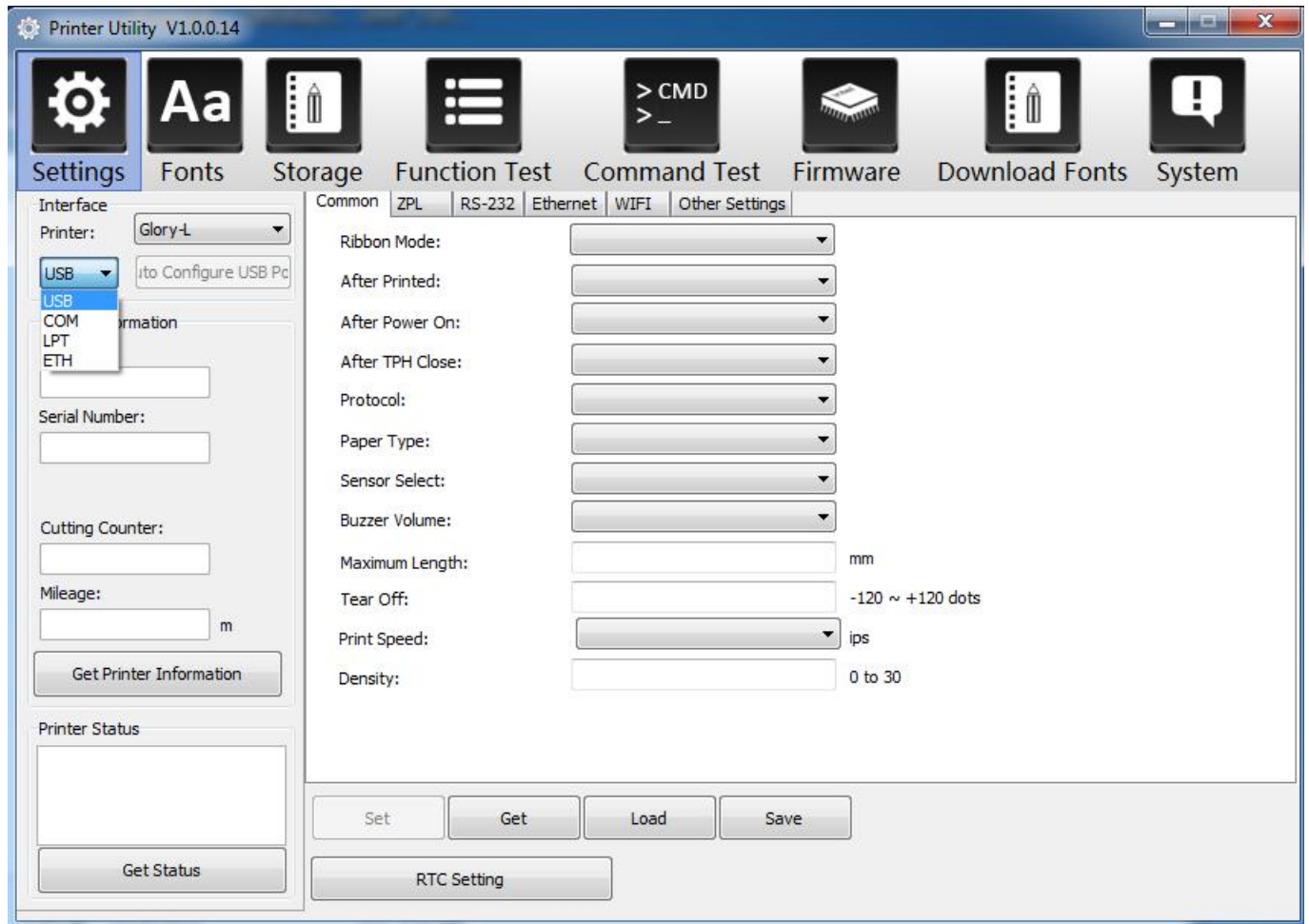

(2) Click “Get Printer Information”, and printer information will show in the above.

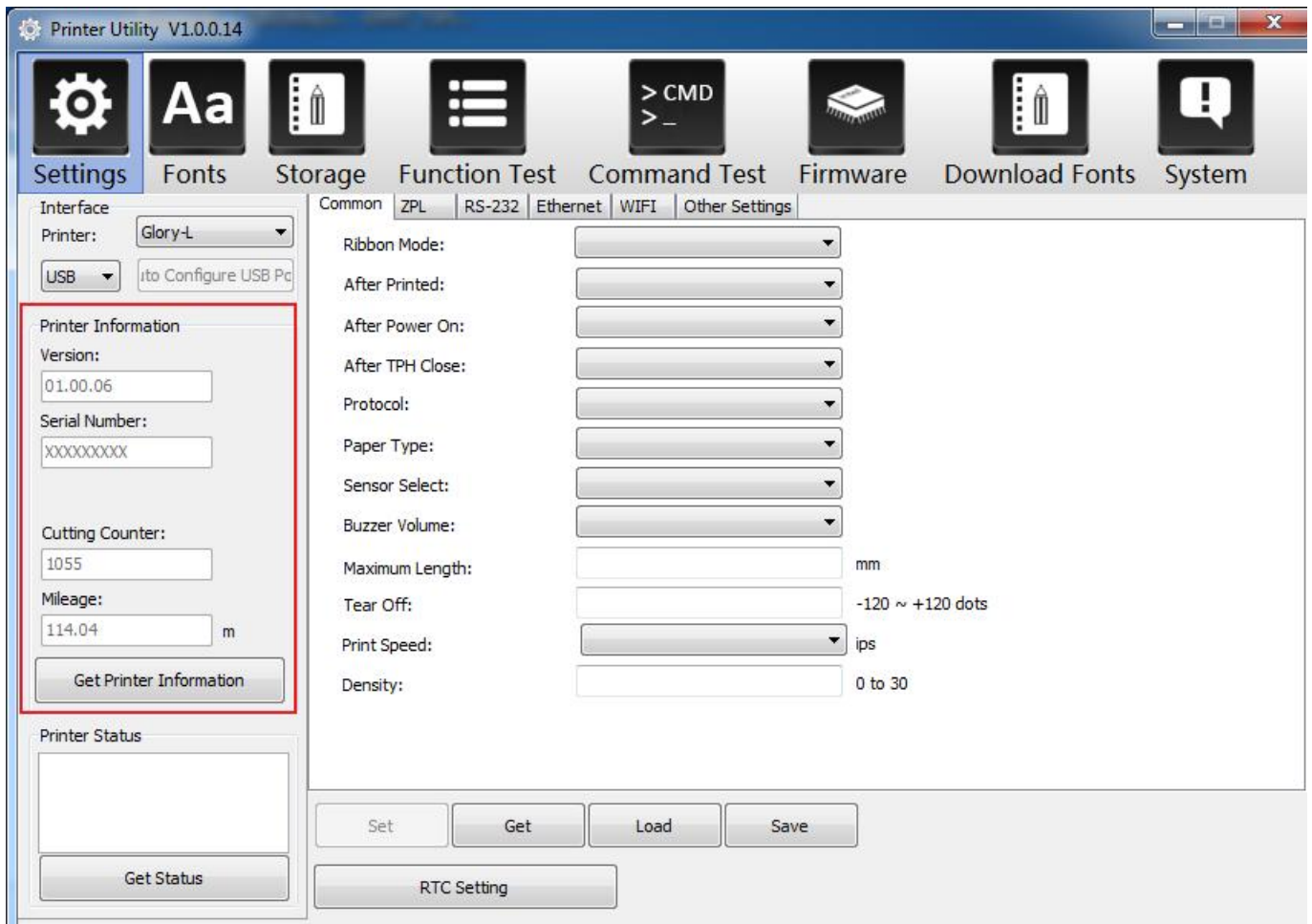

(3) Click “Get Status”, and printer status will show in the above.

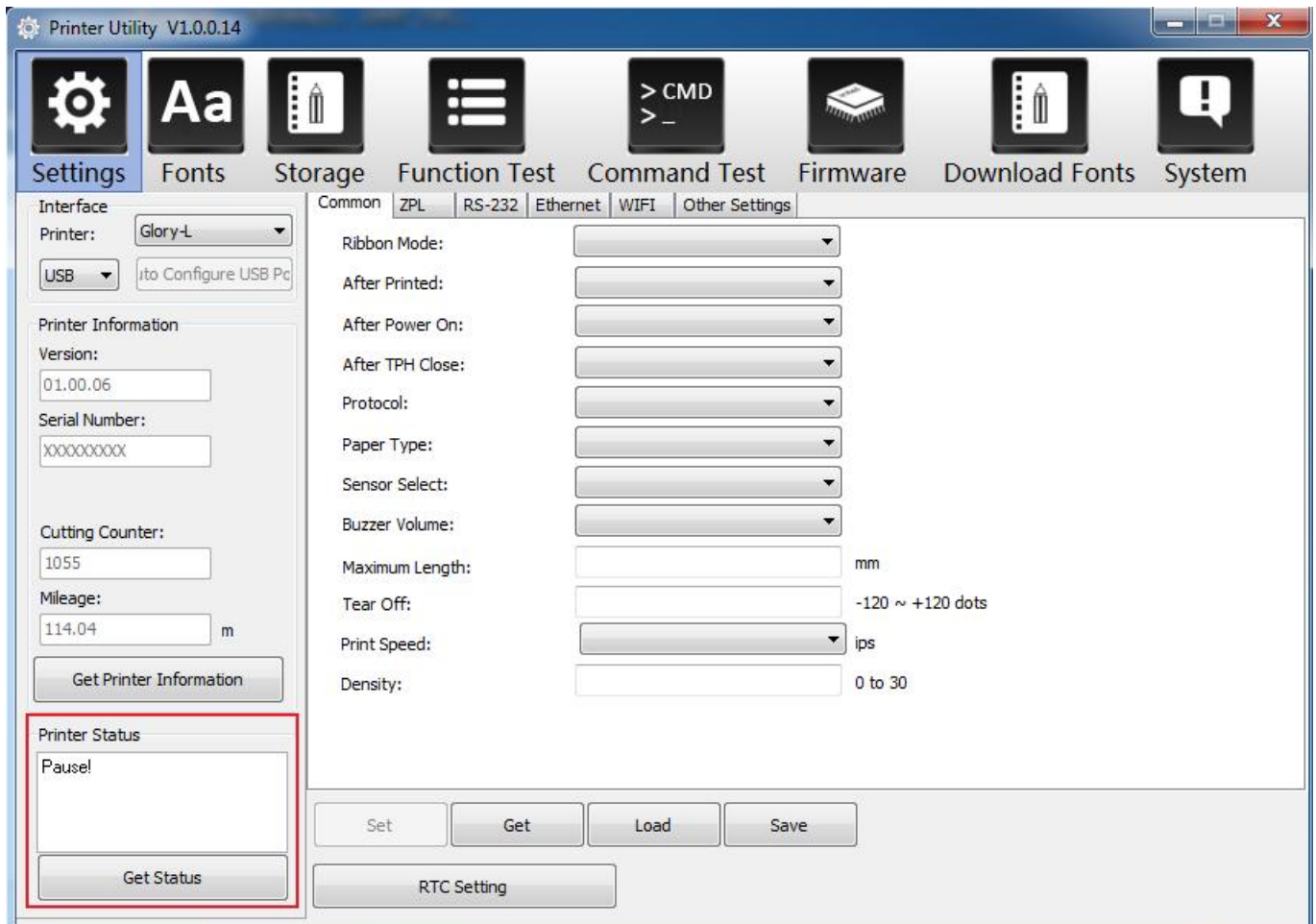

(4) Click “Get”. In this menu, user can set up the protocol, media sensor, speed, density and so on.

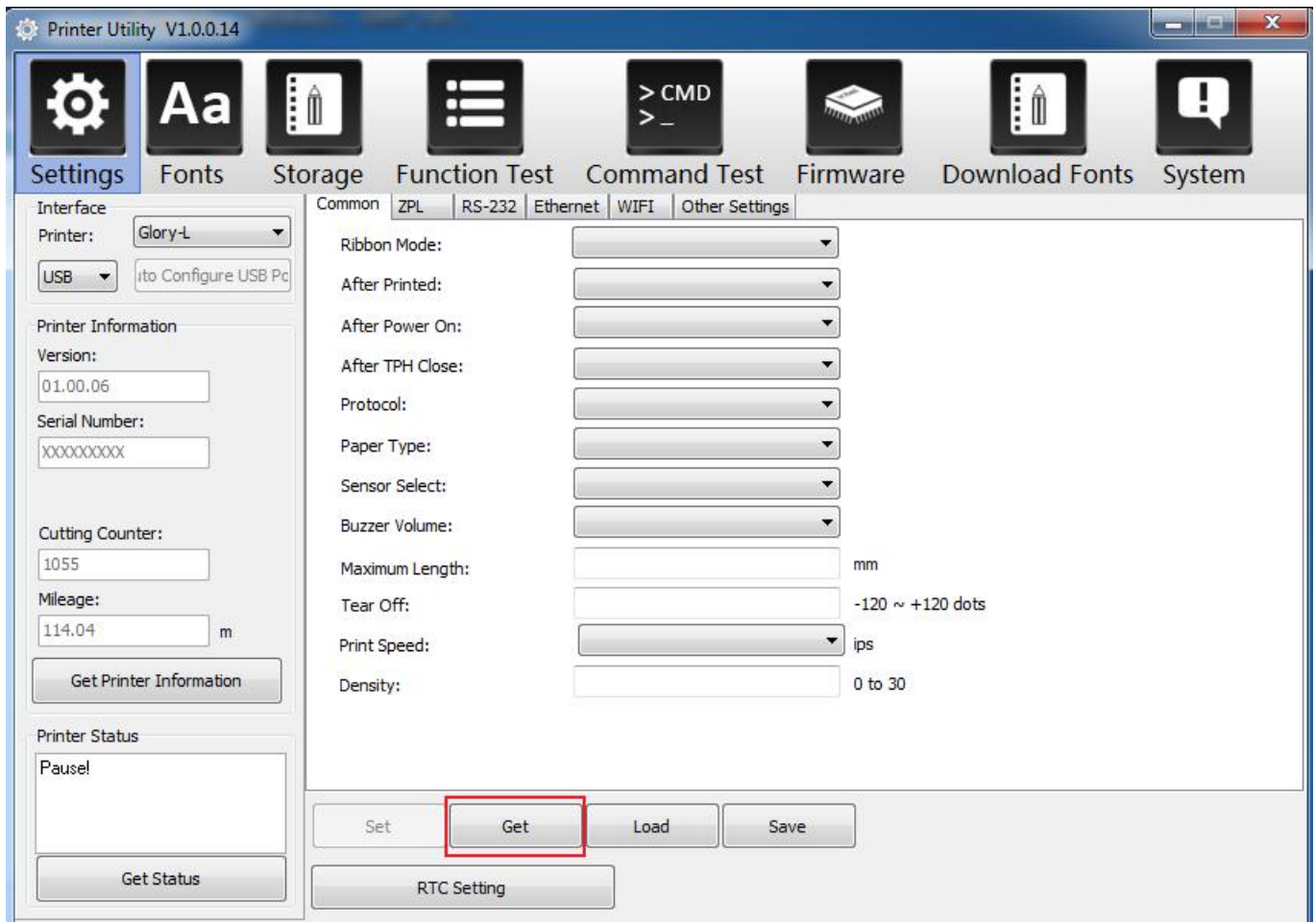

(5) Click “RS-232”, then set up the parameter, or click “Get” to gain the values of Mac address.

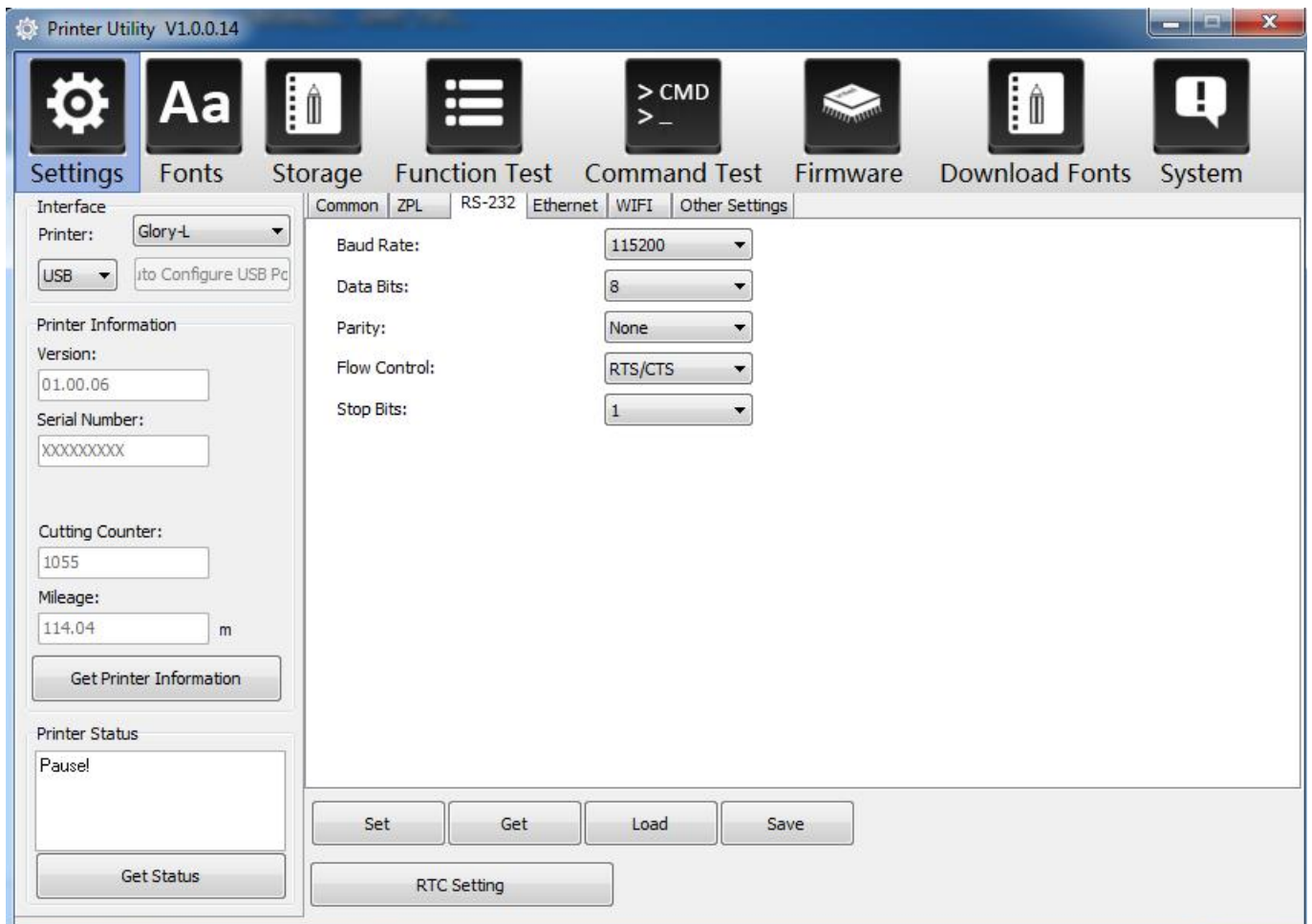

(6) Click “Ethernet”, then click “Get” to gain the relevant values.

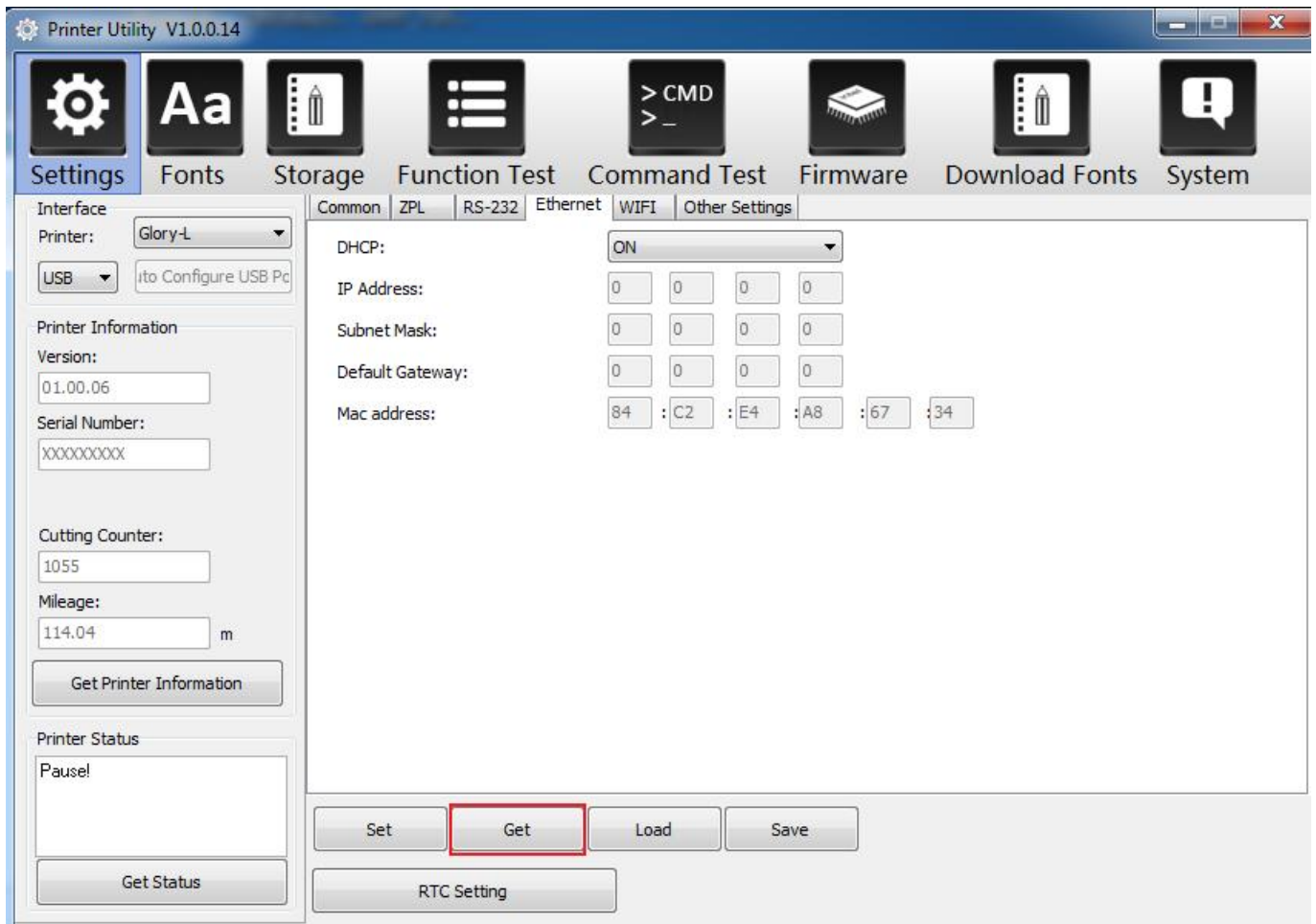

(7) Click “WIFI”, then set up the name, password and so on.

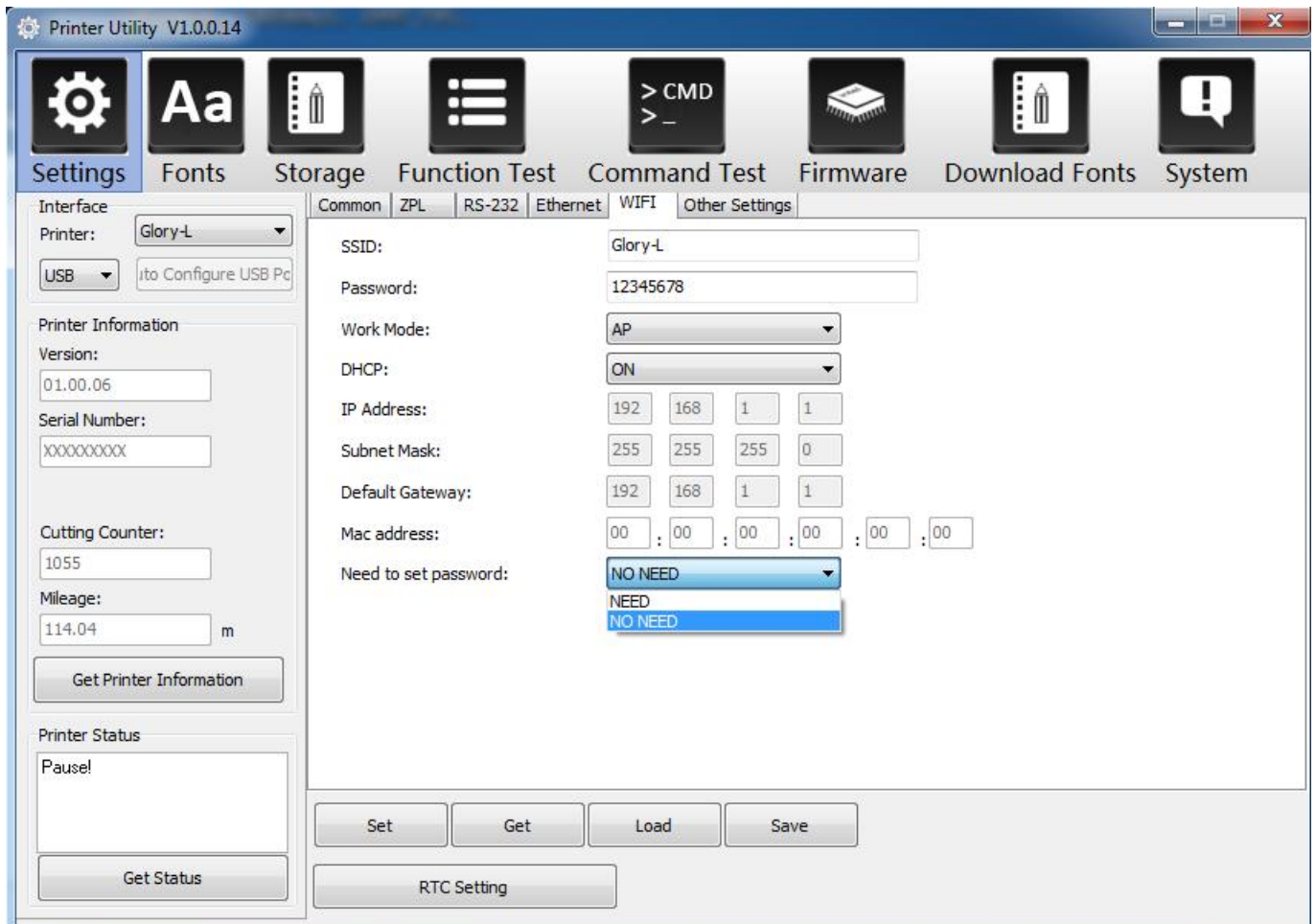

(8) Click “RTC Setting”. Click “Get System DateTime” to get the values, and click “Setup” to save them. Then click “Close”, and back to the main menu.

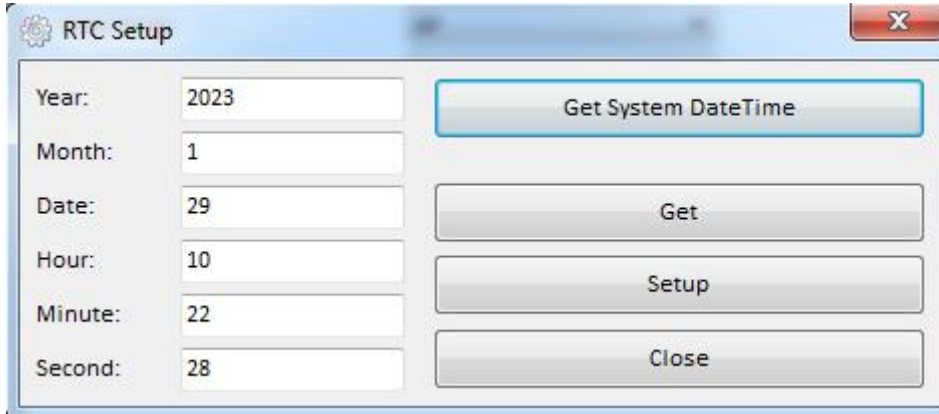

Note:

- ① Finishing all the settings, user can click “Set” to save the values changed.
- ② Click “Get”, and user will get the default values.

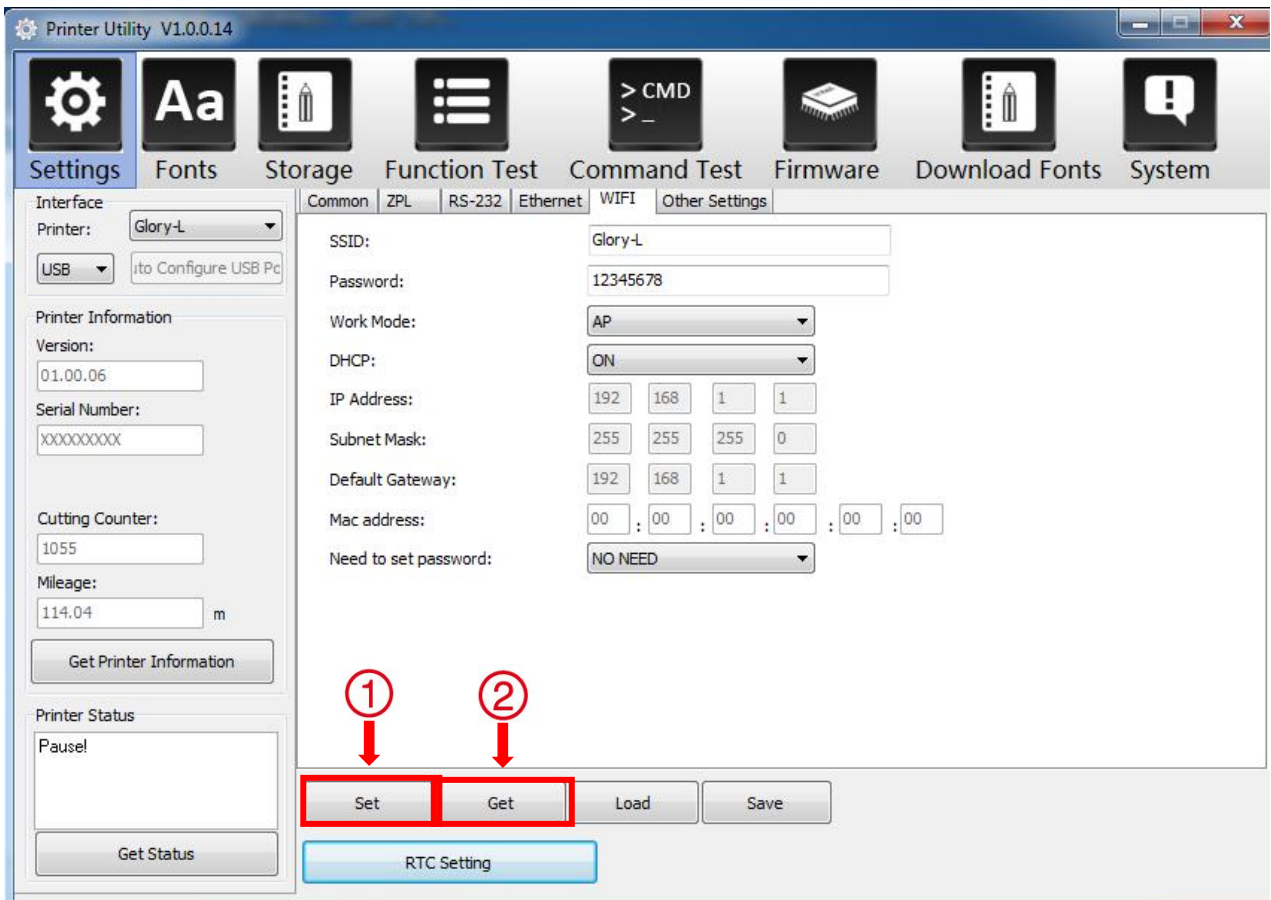

3. Click "Storage" to print image.

The screenshot shows a 'Download File' interface. At the top, there is a 'File Type' dropdown menu set to 'Graphics' and a 'Magnification' dropdown menu set to '1.0'. Below these is a 'File Name' input field followed by a button with three dots and a 'Download' button. Underneath, it displays storage information: 'Free space: 119,401,472B; Uses space 286,790,656B.' The main area is divided into three columns: 'Graphics', 'Label Form', and 'Auto Label Form'. Each column contains a large empty box and a set of four buttons: 'List All [Category]', 'Print Selected [Category]', 'Delete Selected [Category]', and 'Delete All [Category]'. The 'Auto Label Form' column also includes an 'Enable Auto Form' button.

(1) Click "File name" to select the image.

This is a close-up screenshot of the 'Download File' interface. It shows the 'File Type' dropdown set to 'Graphics', the 'Magnification' dropdown set to '1.0', and the 'File Name' input field. A red box highlights the button with three dots next to the input field, indicating that this button is used to select a file. The 'Download' button is also visible to the right. The storage information is shown at the bottom: 'Free space: 119,401,472B; Uses space 286,790,656B.'

Note: The file name must be in English or number, and the filename length must be less than 32.

(2) Click “Download”.

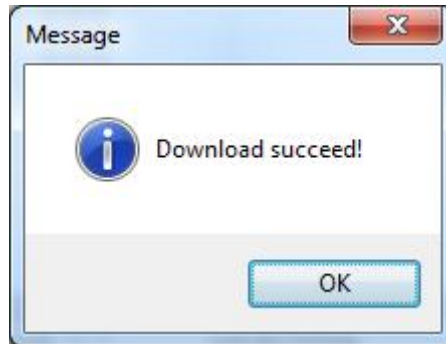

(3) Select the downloaded graphic, and then click “print selected graphic” to print the picture.

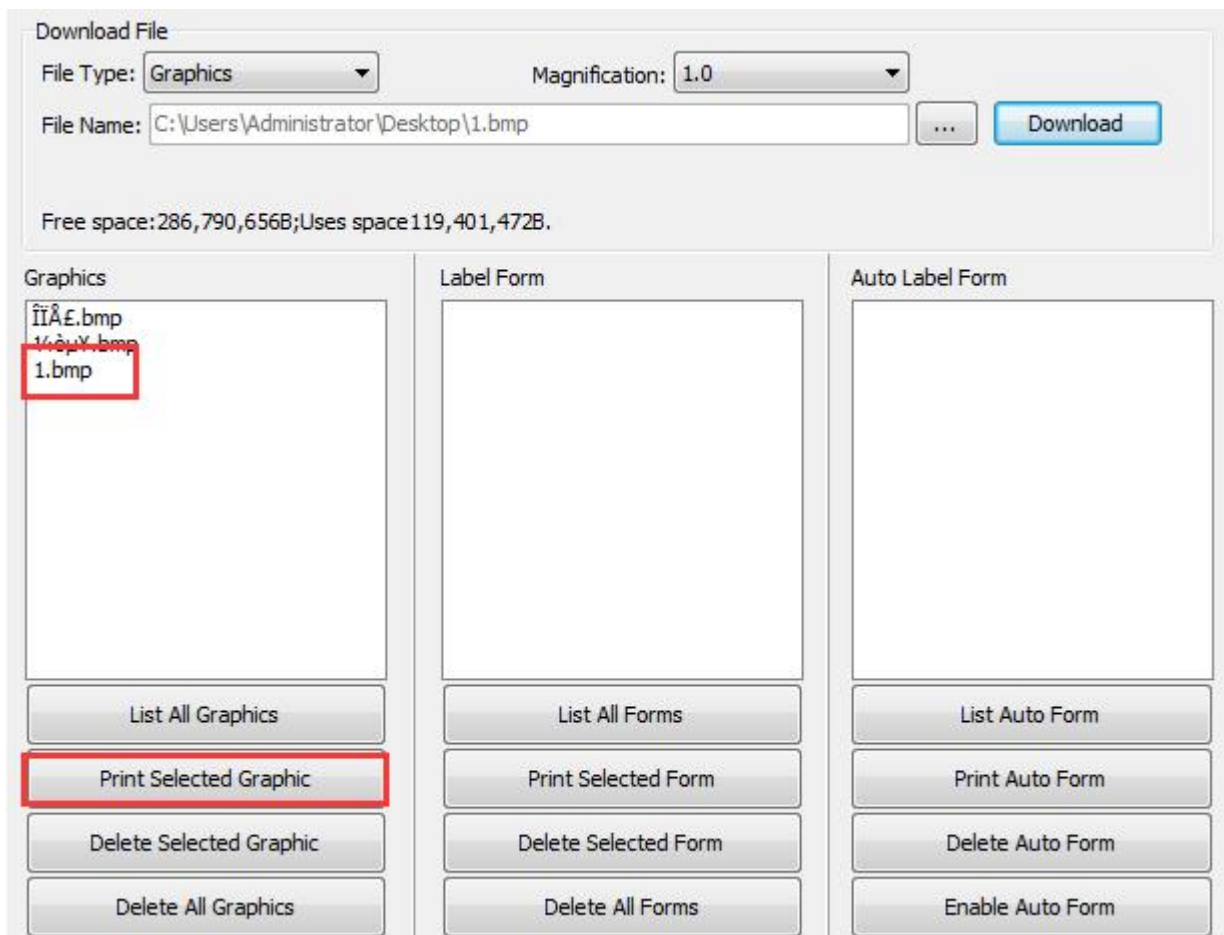

(4) You can set a magnification of the graphic as needed.

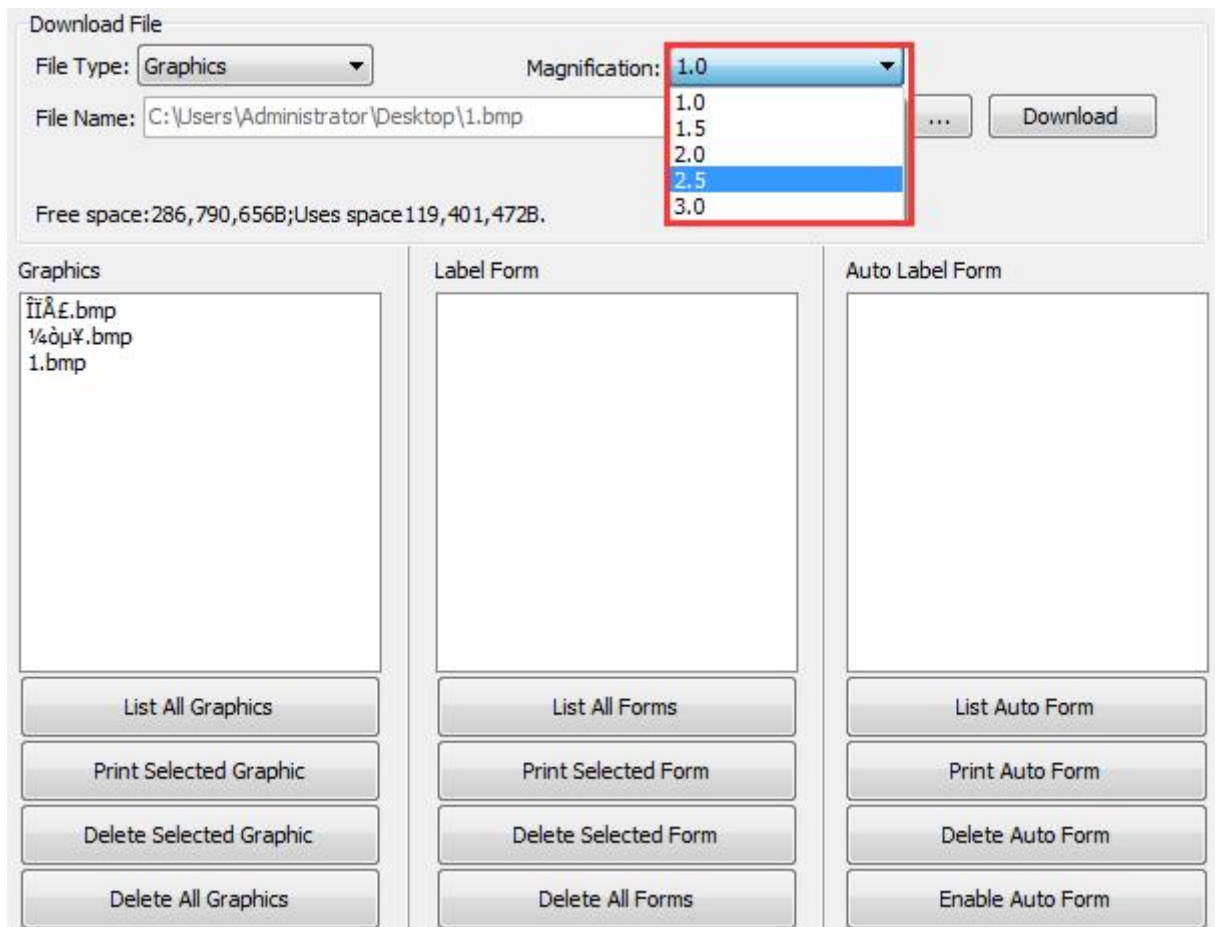

(3) Select the downloaded font file, enter the print content in the text box, and click “Print Text”.

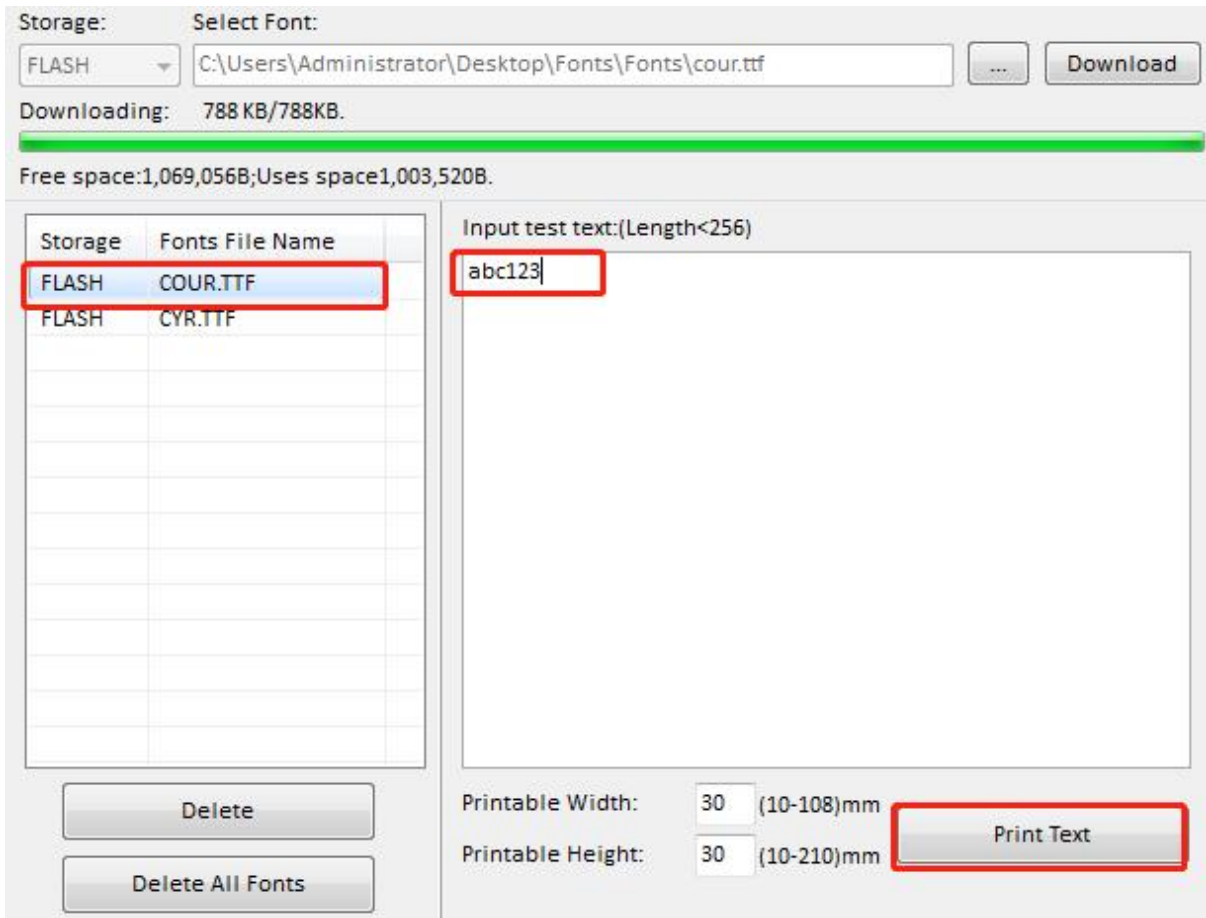

5. Click “Function Test”. User can carry the followings such as sensor calibration, pattern print testing and so on.

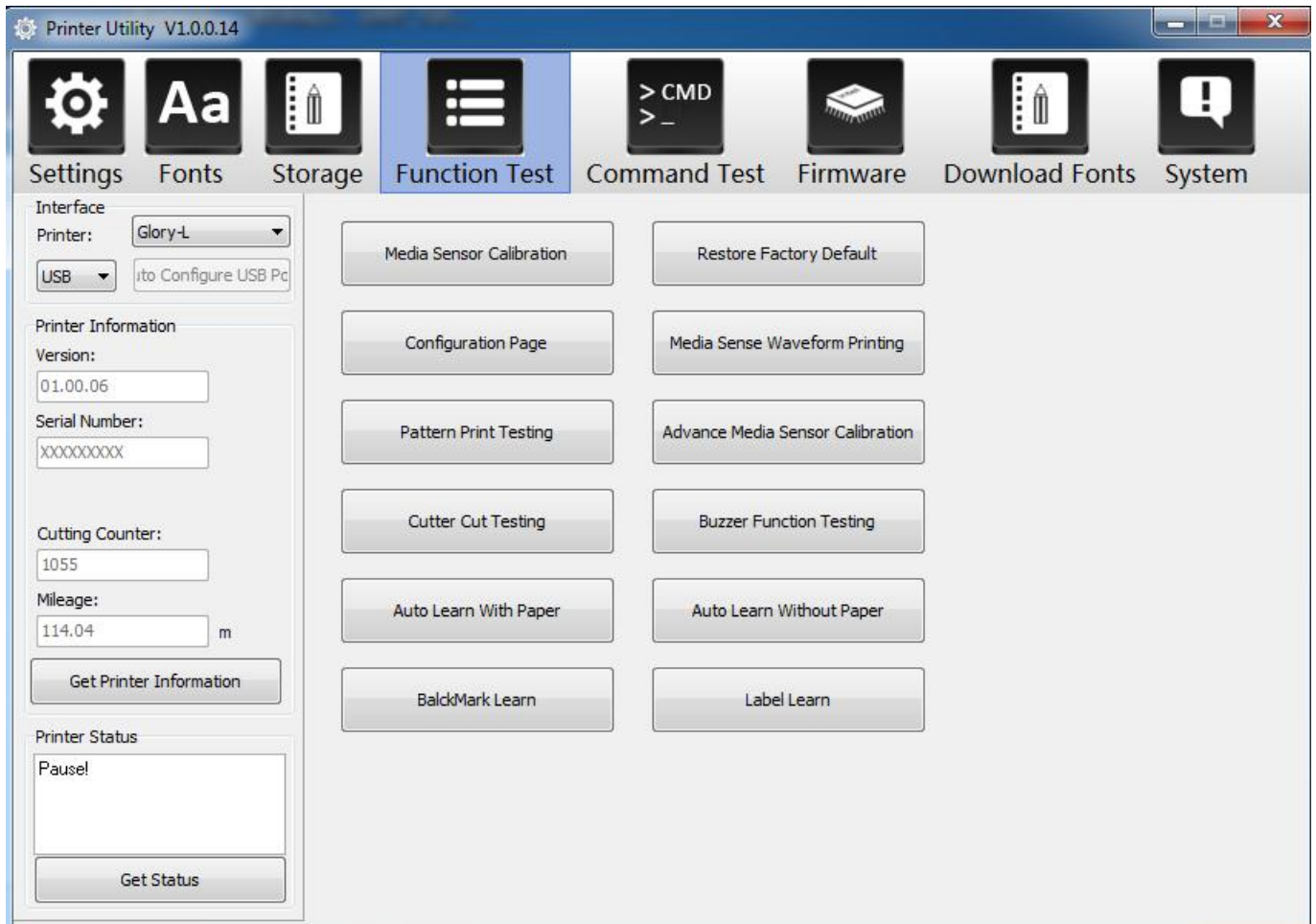

6. Click “System”. Click “language” and choose the language of printer utility.

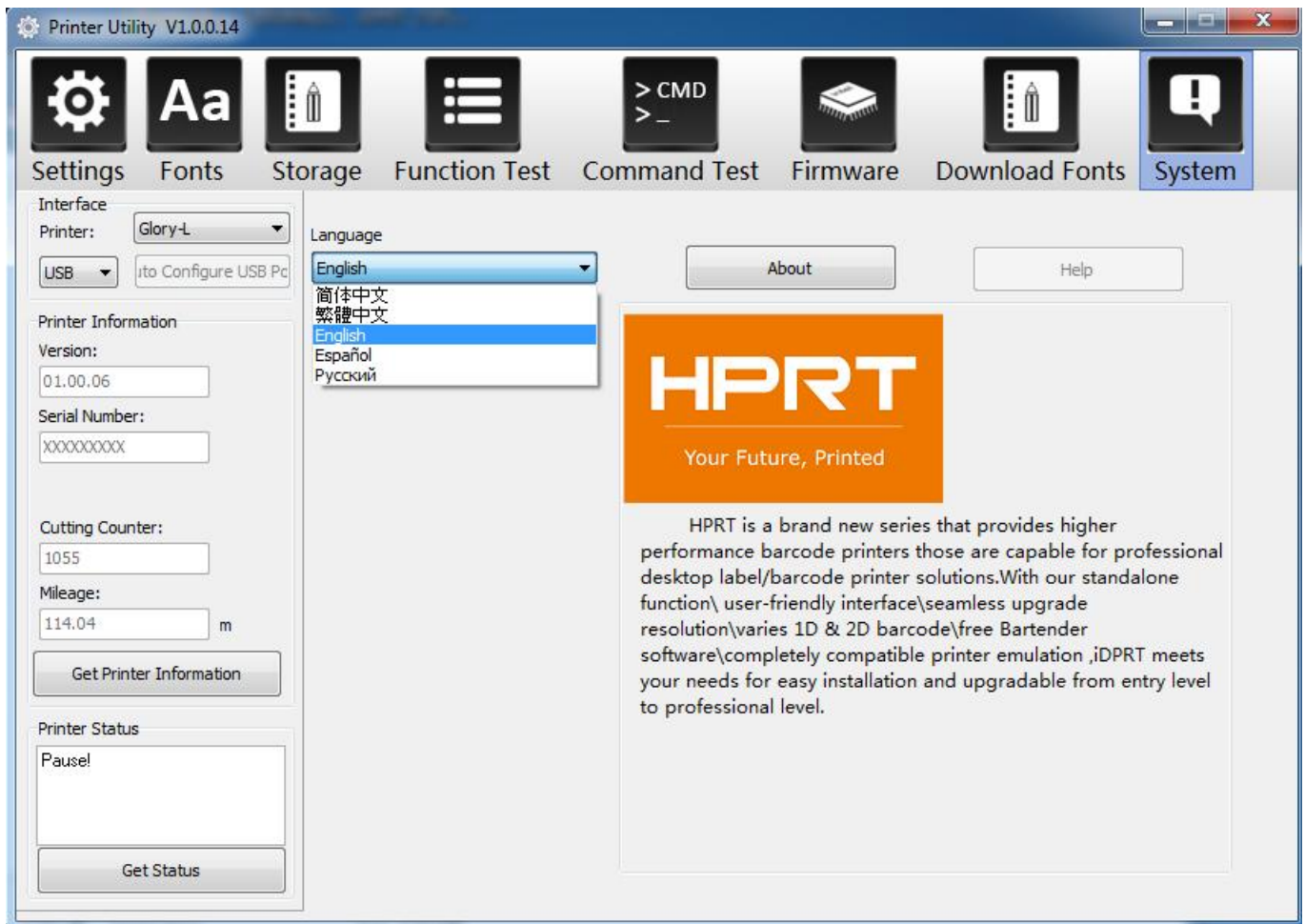

Chapter 7 Seagull Windows Driver Instructions

7.1 Introduction

The following operating systems are supported:

- Windows Vista, Windows 7, Windows 8 and 8.1, and Windows 10.
- Windows Server 2008, 2008 R2, 2012, 2012 R2, and 2016.
- 32-bit and 64-bit (x64) editions.

7.2 Installation Preparation

Download Seagull Windows Driver application program in CD.

7.3 Installation



Note:

- Under different operating systems, the screen may be slightly different. Take Windows 7 as example.
- Take printer Bravo-L as example.
- To avoid the prevention, recommend to close the security software before installation.

1. Select one interface to connect your printer to computer.
2. Turn on the printer and check if it is connected to computer successfully.
3. Double click Seagull Windows Driver .
4. Read and agree the license agreement. Then click "Next".



5. Choose the installation directory, then click "Next".

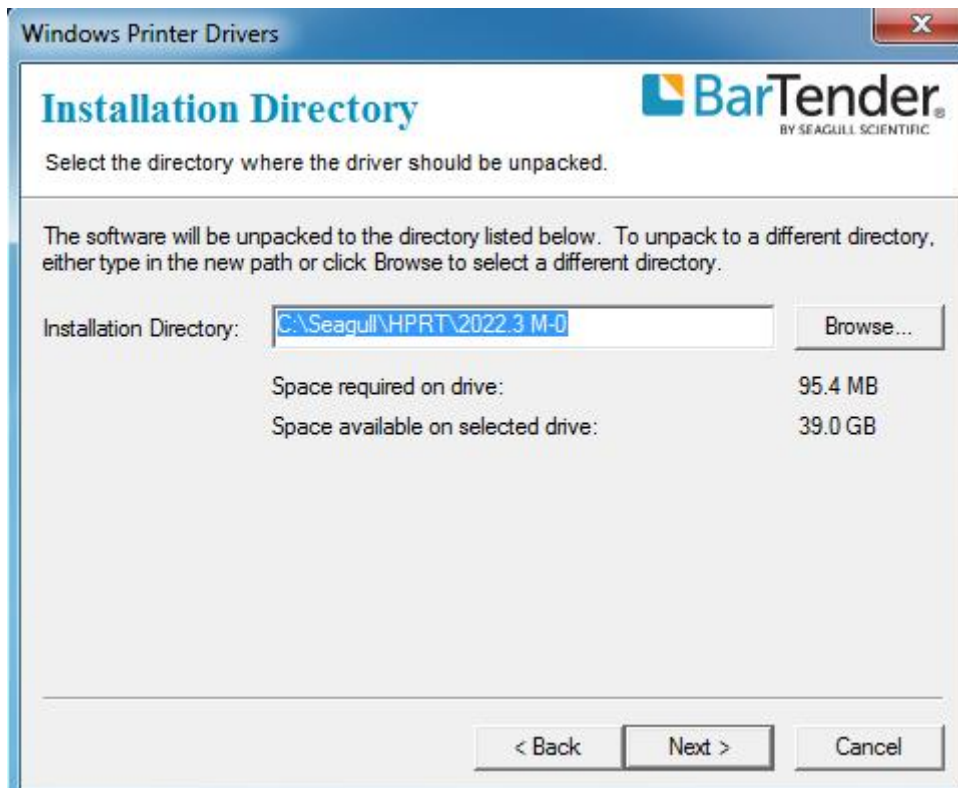

6. Click "Finish".

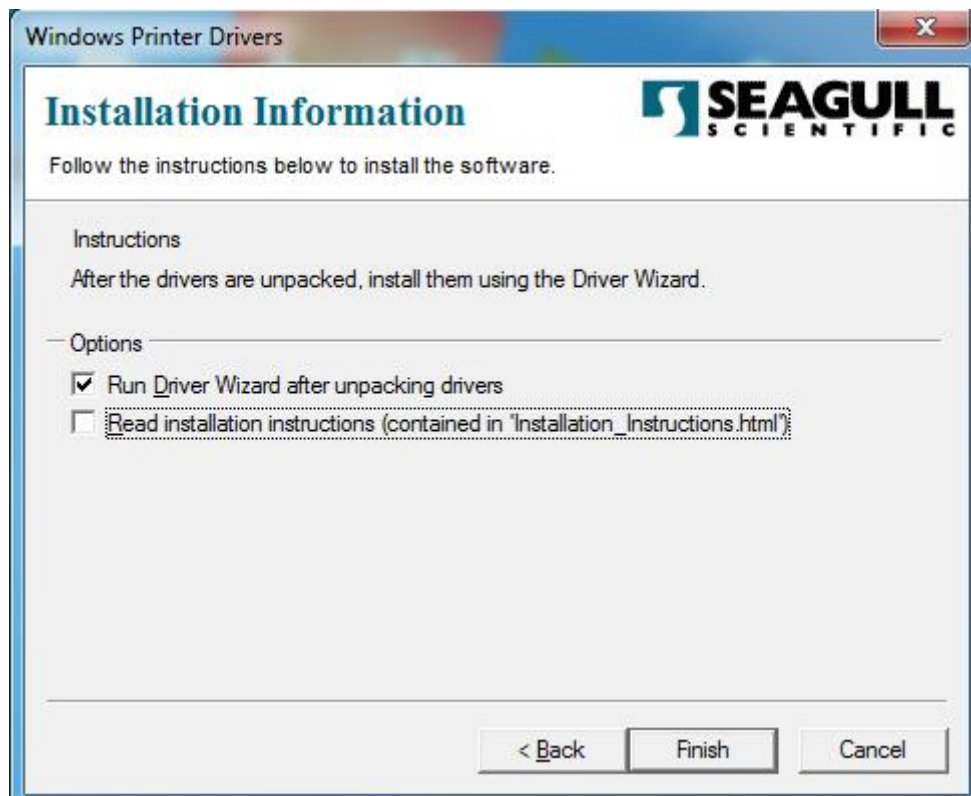

7. Choose "Install printer drivers", then click "Next".



Note: If you have connected the printer to computer, it will detect and install the driver automatically. (e.g. USB port)

8. Choose model, then click "Next".

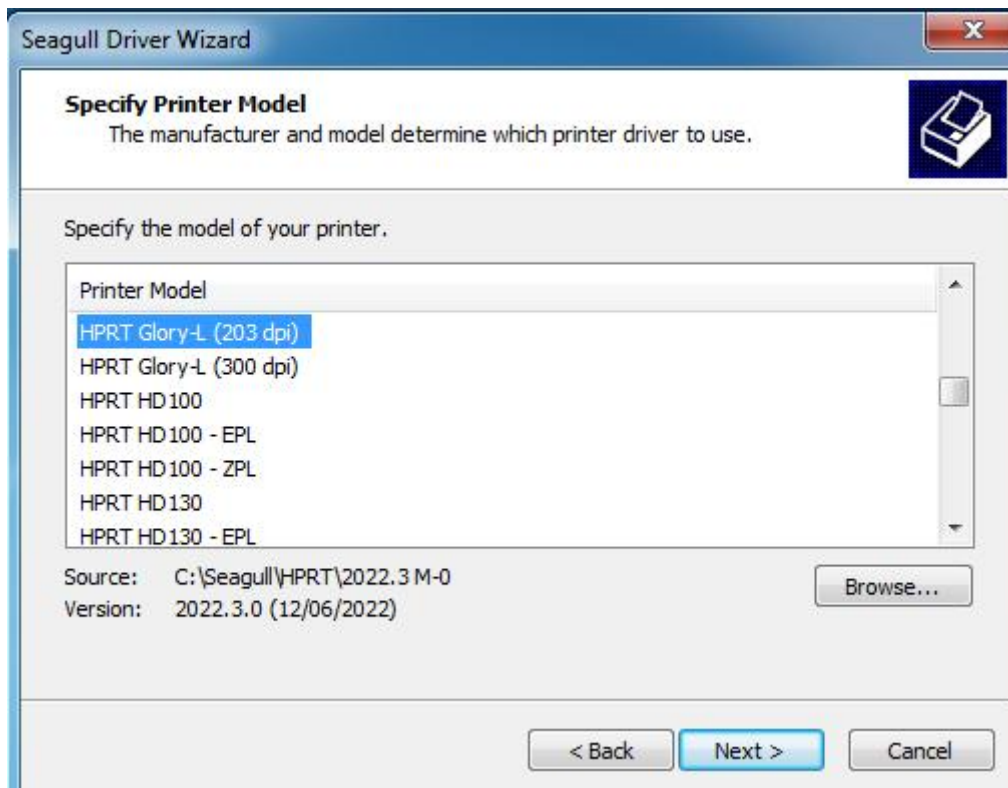

9. Enter a name for this printer, then click "Next".

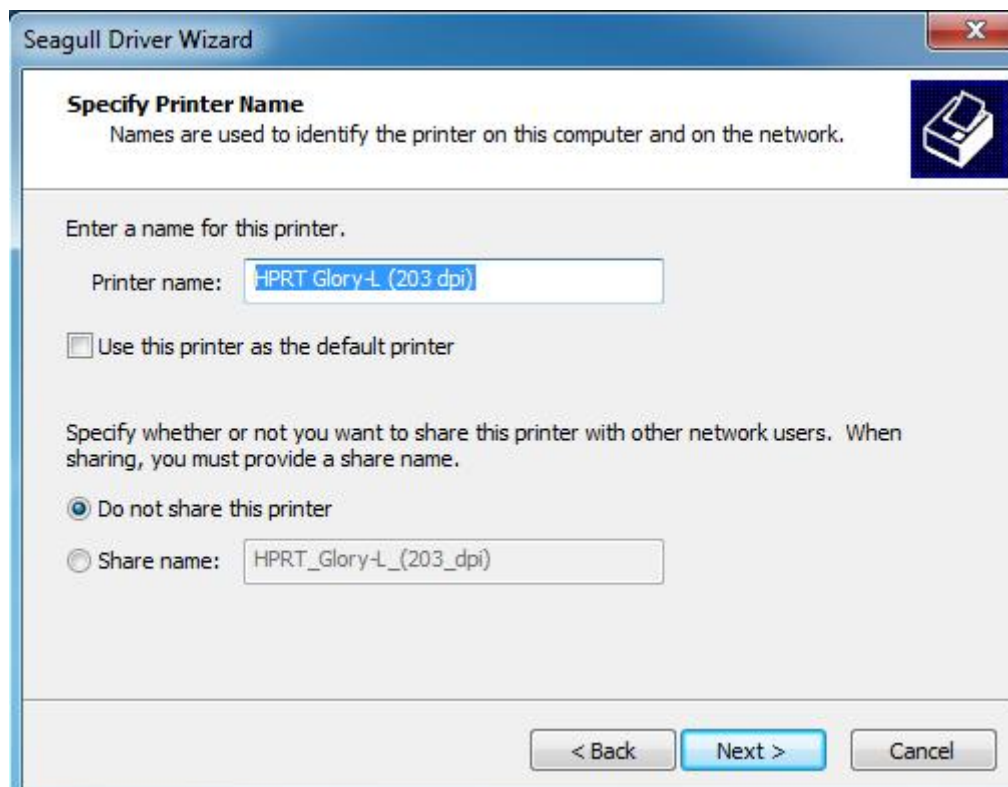

10. Click "Finish".



11. Click "Close", and the driver is installed successfully.

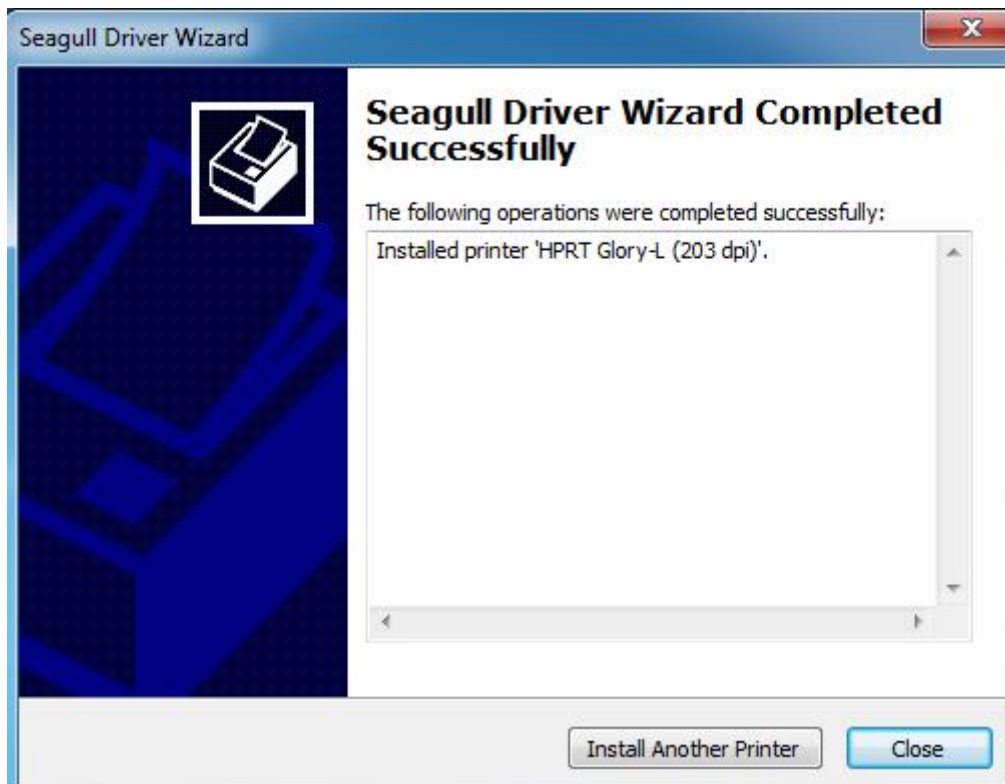

12. After installation, the icon will be found in “Start” → “Devices and Printers”.



Note:

- **If you have already installed the driver (No matter what kind of ports), it will generate a USB port automatically when connecting the printer to computer.**
- **Any problems exist, please use our utility tool in CD.**

7.4 Usage

7.4.1 Printing Preferences

1. Click "Start" → "Devices and Printers". Right click icon and choose "Printing preferences".

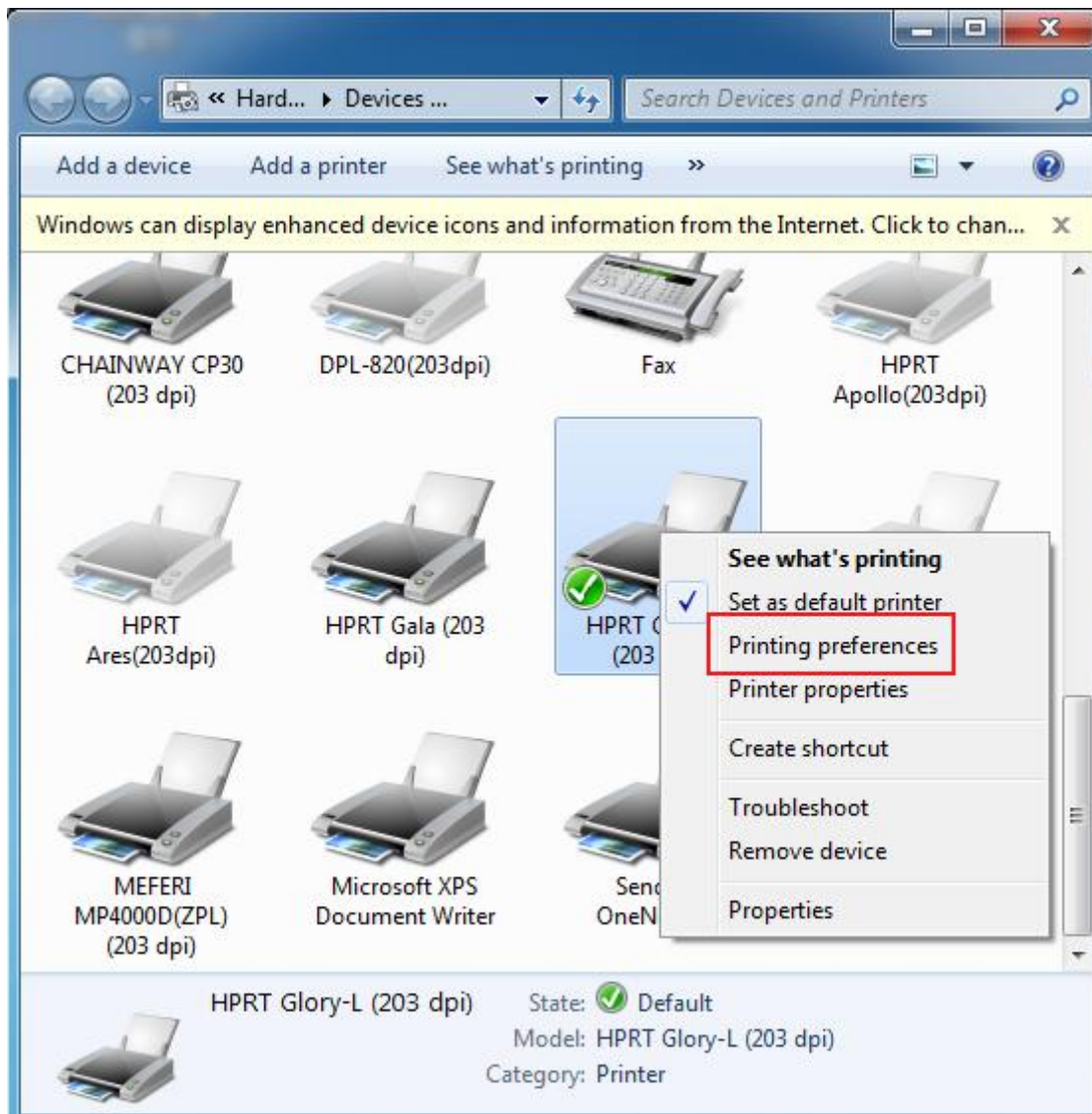

2. According to different needs, set up the page.

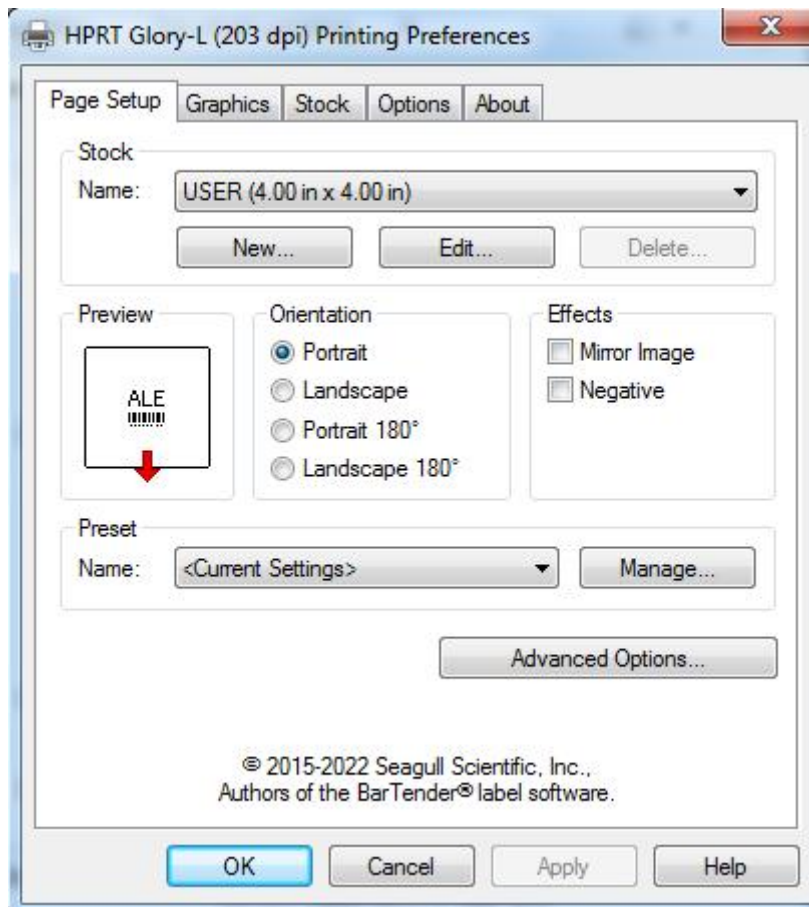

- Click “Stock” → “Name”, and choose the paper type.

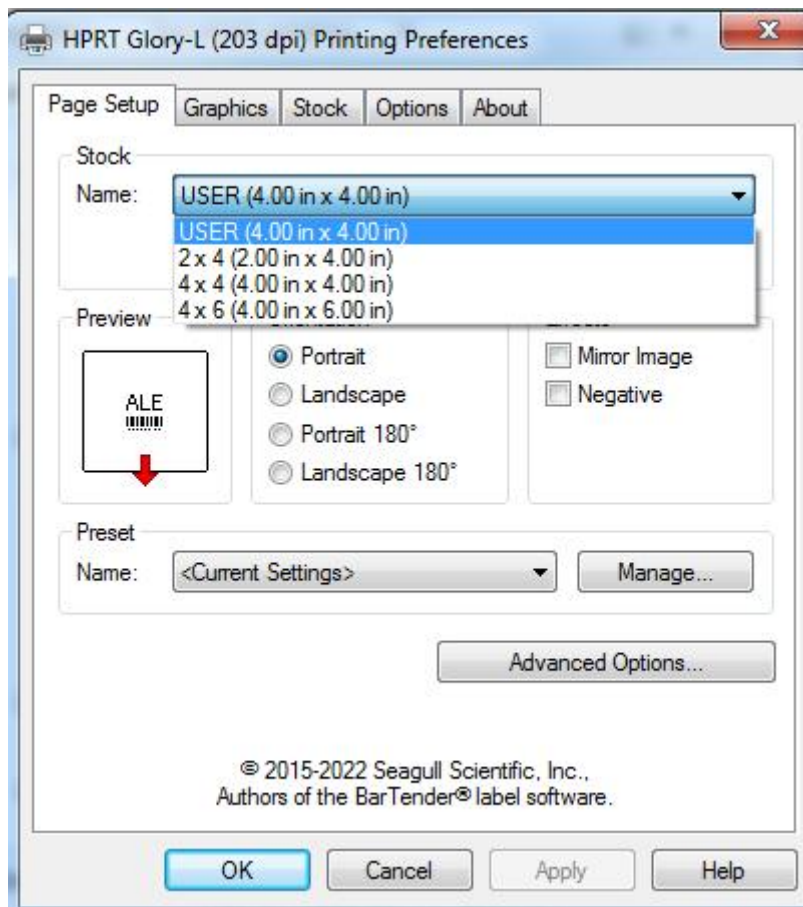

- Click “New Stock”, and set up a new stock.

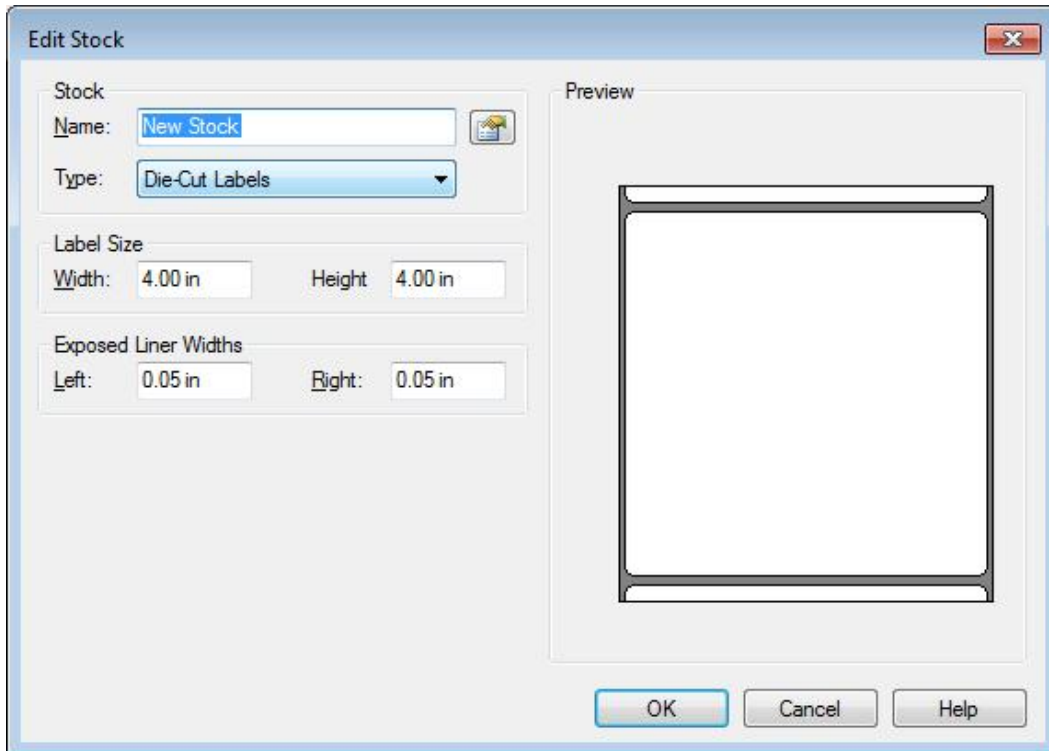

- Click “Edit Stock”, and edit the stock.

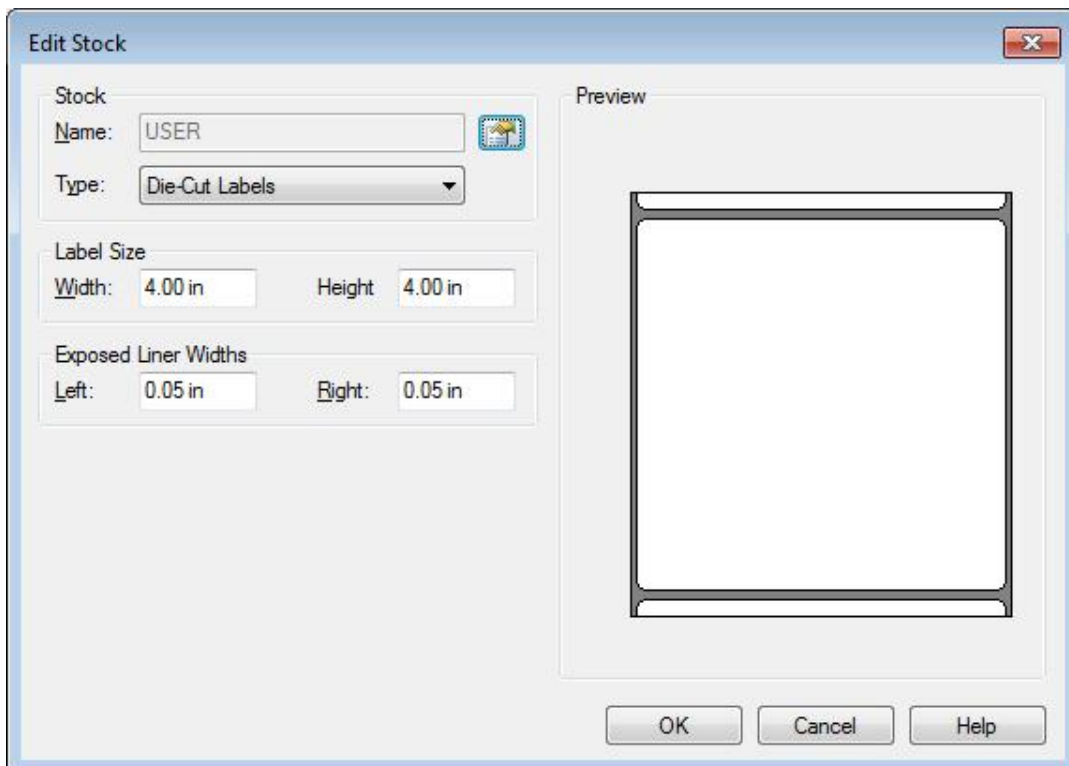

- Click “Delete Stock”, and delete the stock.

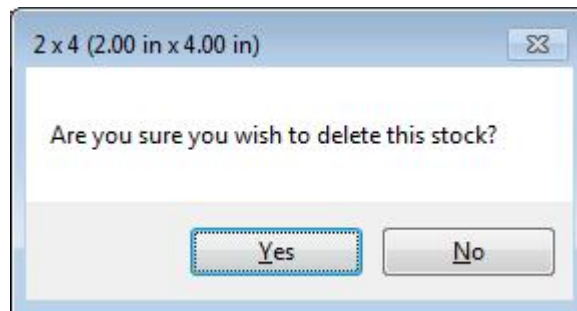

- Choose “Orientation” or “Effects”, showed in the “Preview”.

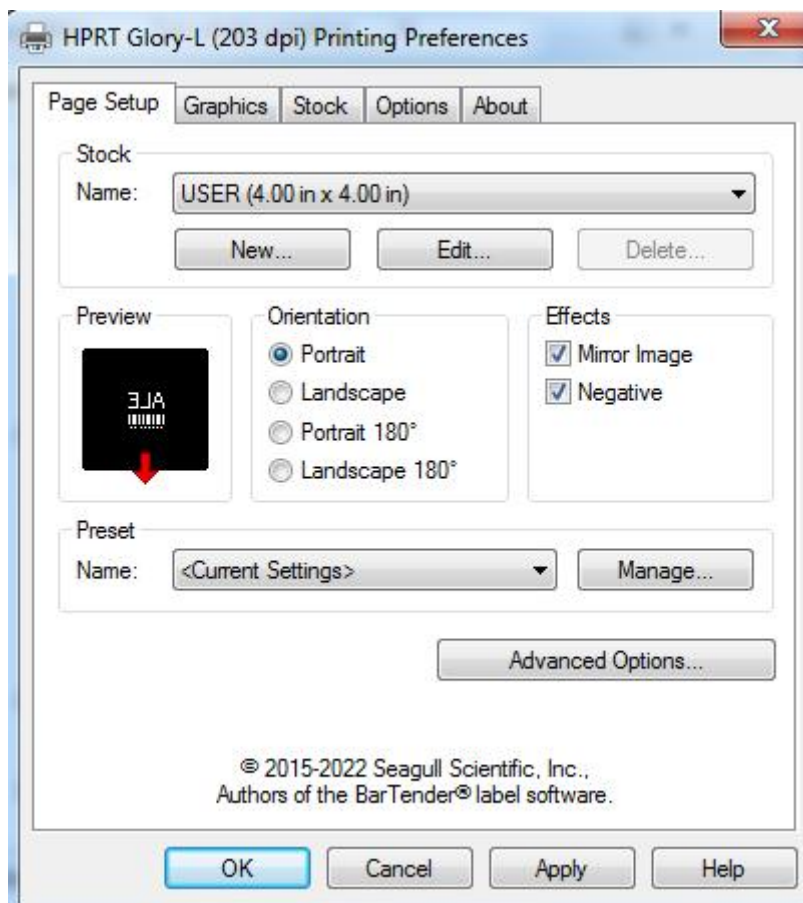

- Click “Preset” → “Name”, and back to the default settings.

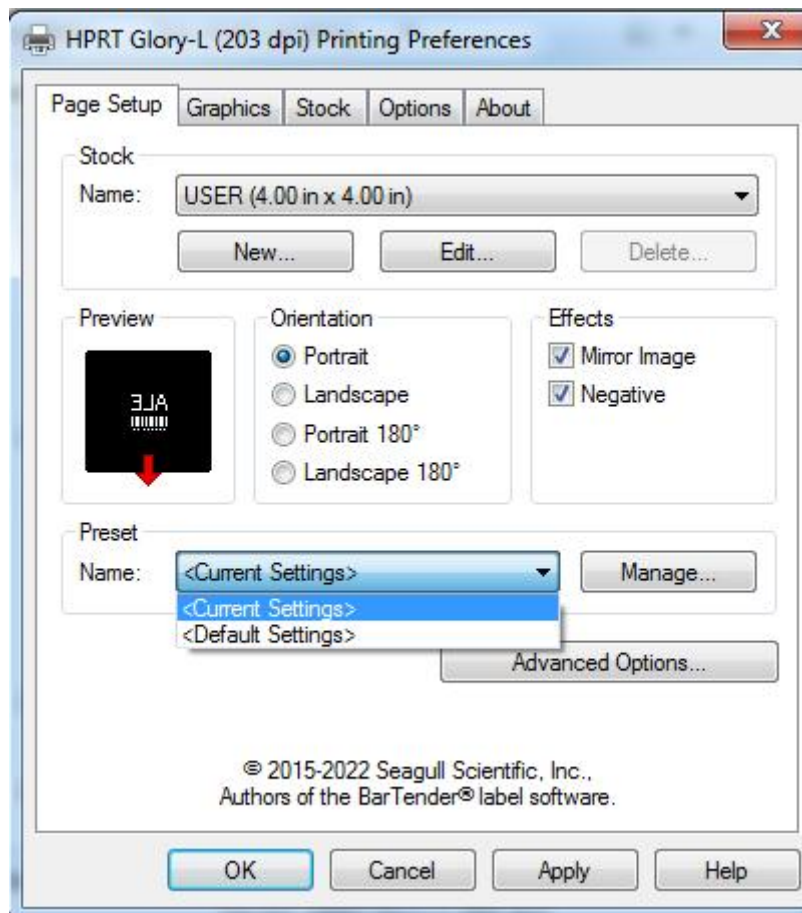

3. Click "Graphics", and edit the pictures.

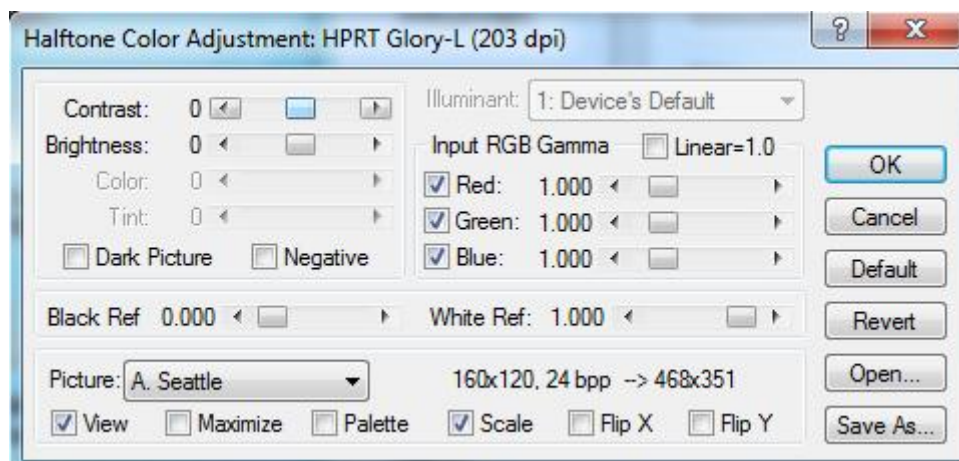
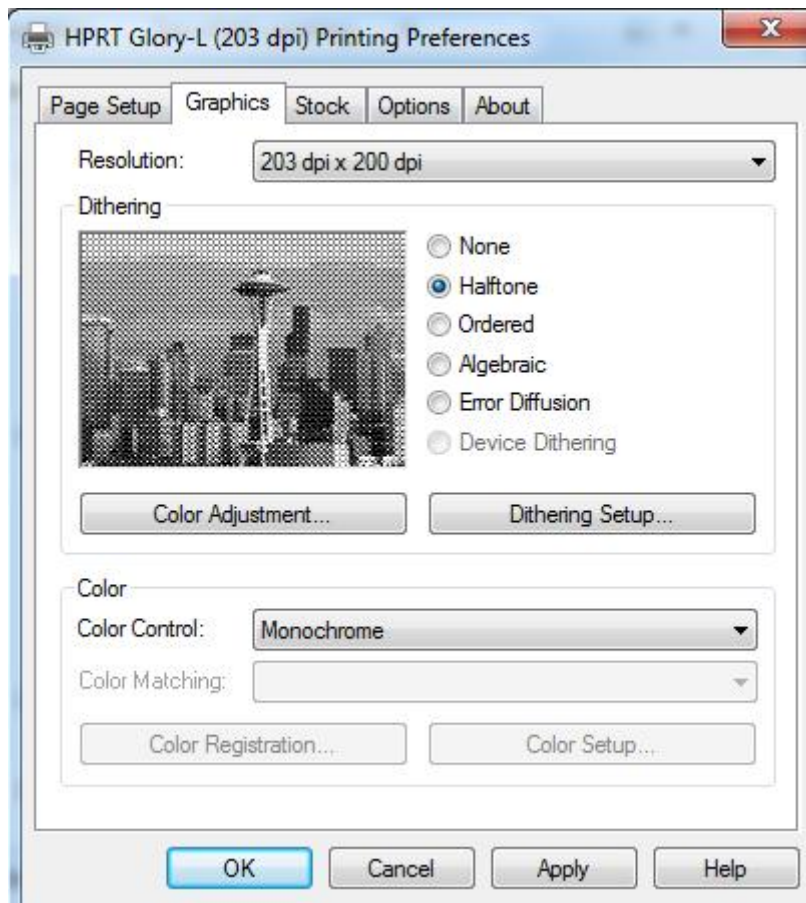

4. Click “Stock”, set the media settings, feed mode and feed options.

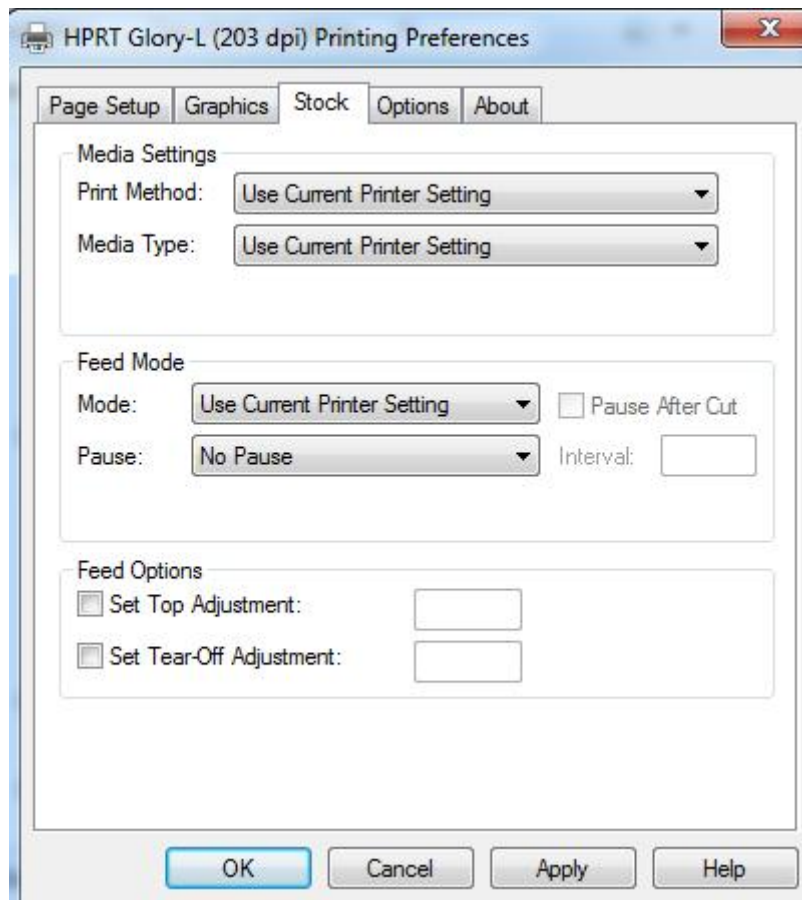

- Set up the print method (Direct Thermal / Thermal Transfer).

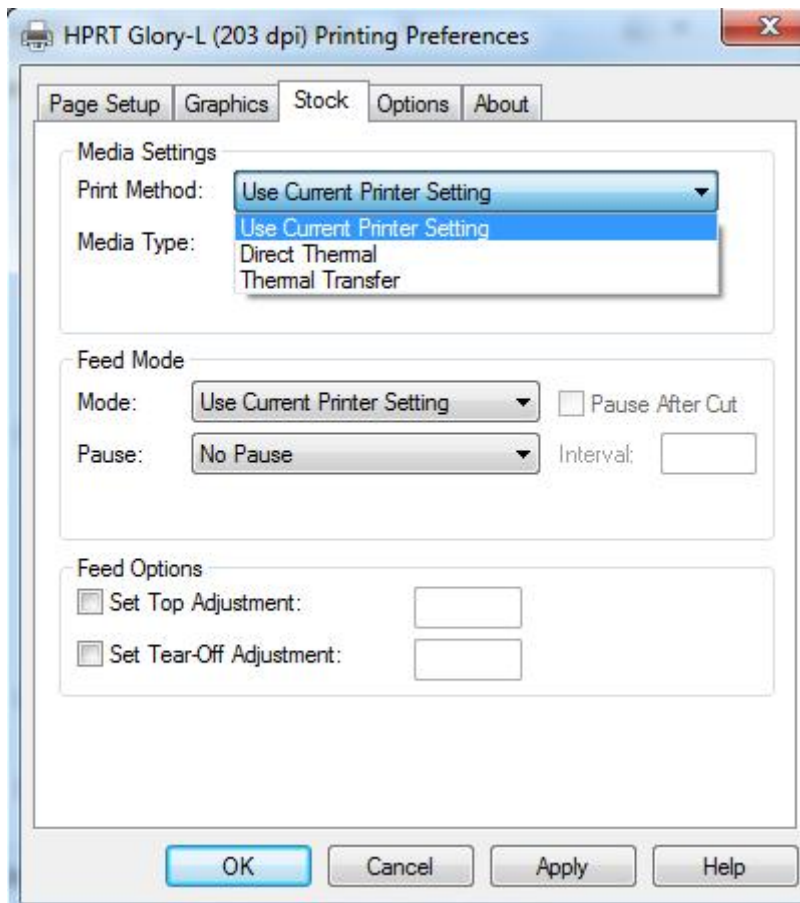

- Set up the media type.

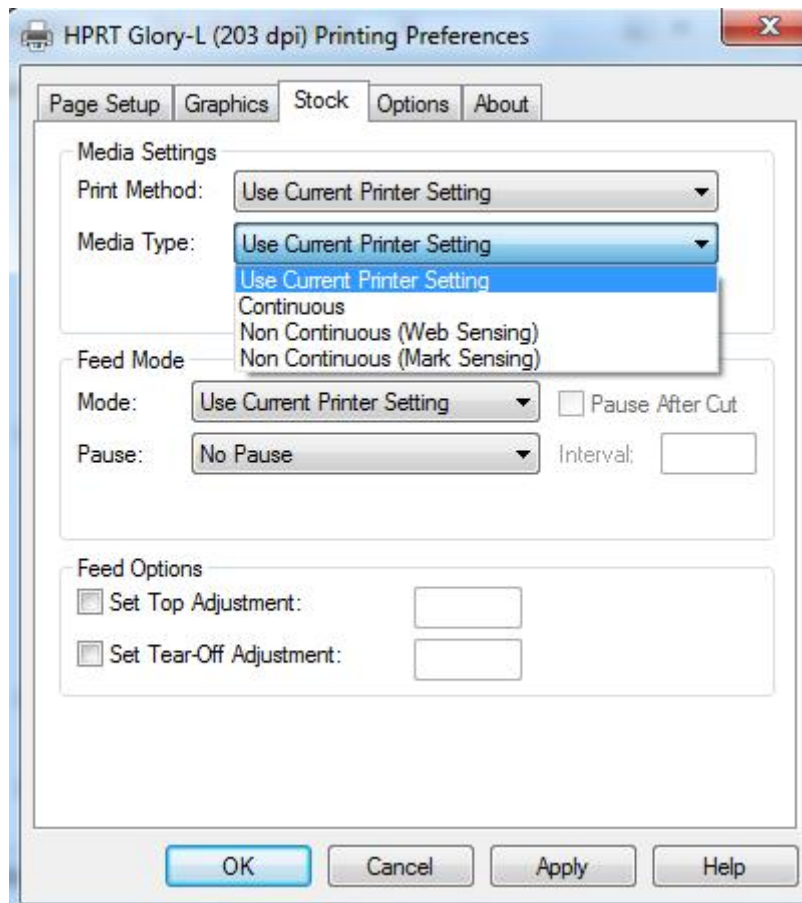

- Click “Feed Mode” → “Mode”, and choose the method of media handling.

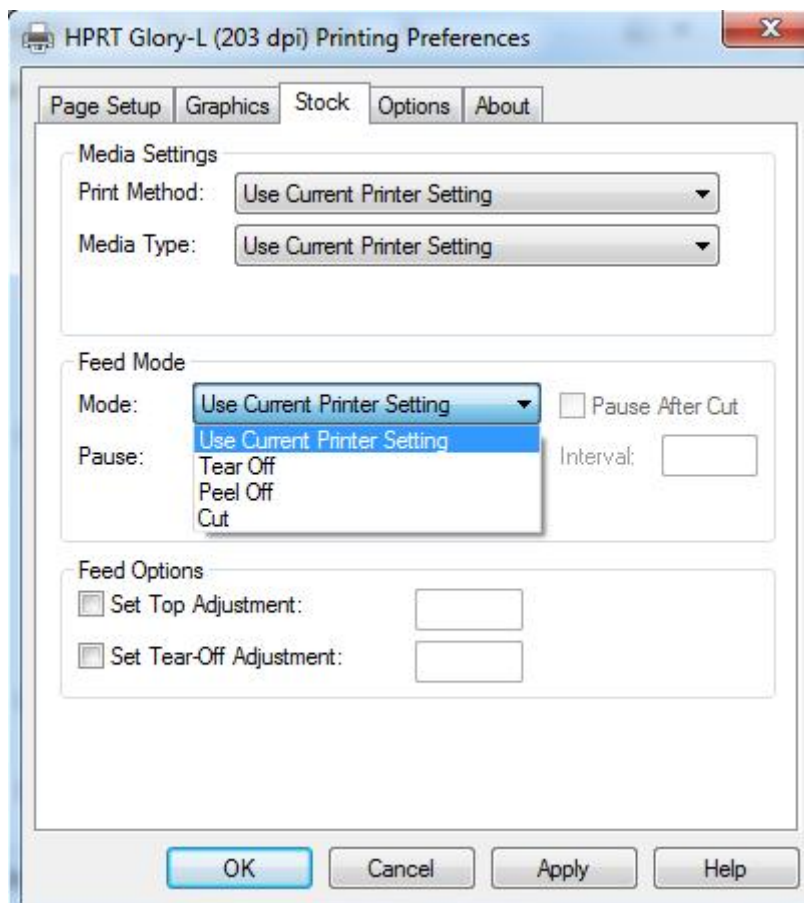

7.4.2 Printer Properties

1. Click “Start” → “Devices and Printers”. Right click the icon and choose “Printer properties”.

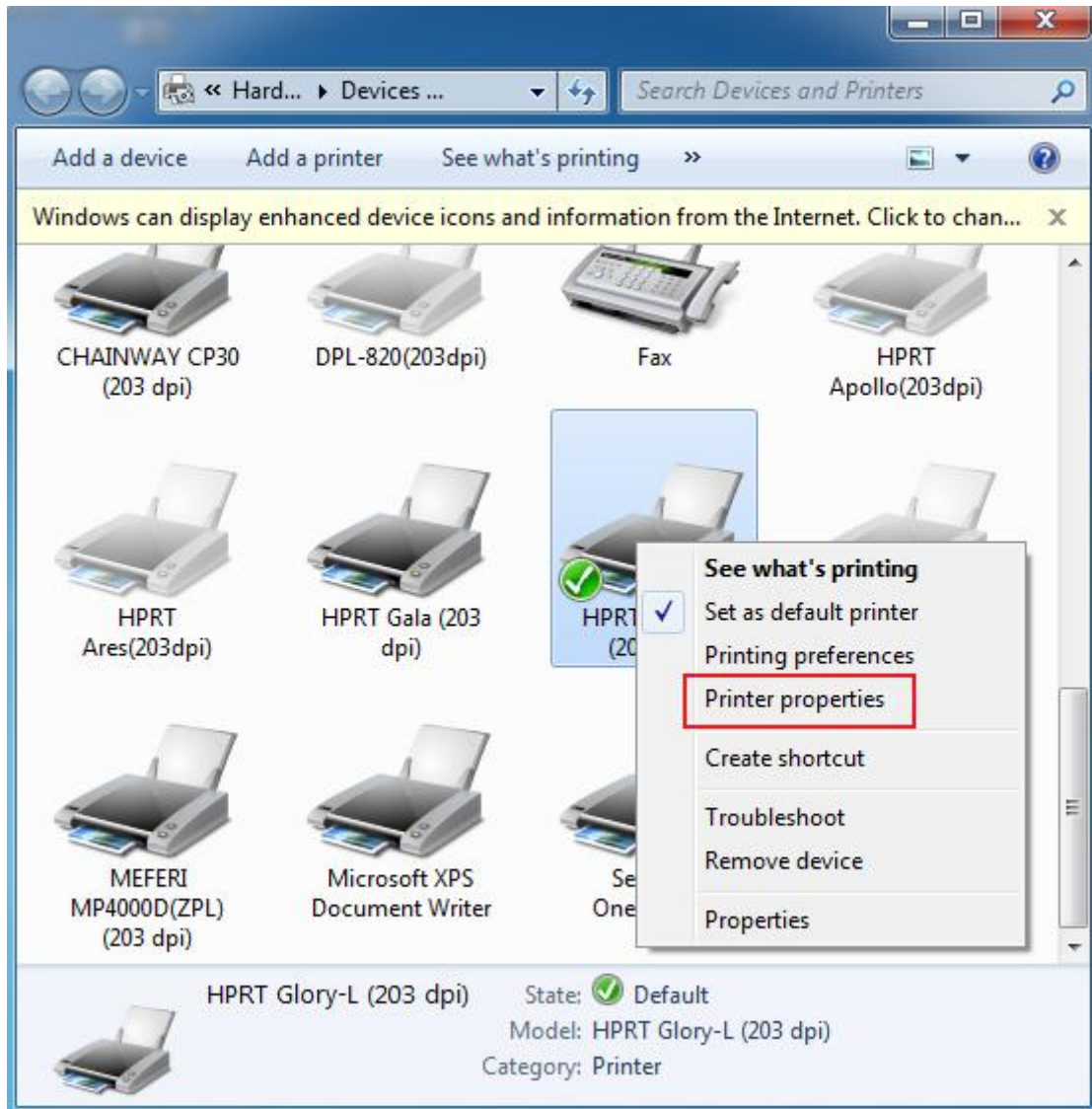

2. Click "General" → "Print Test Page", and printer will print labels with current settings.

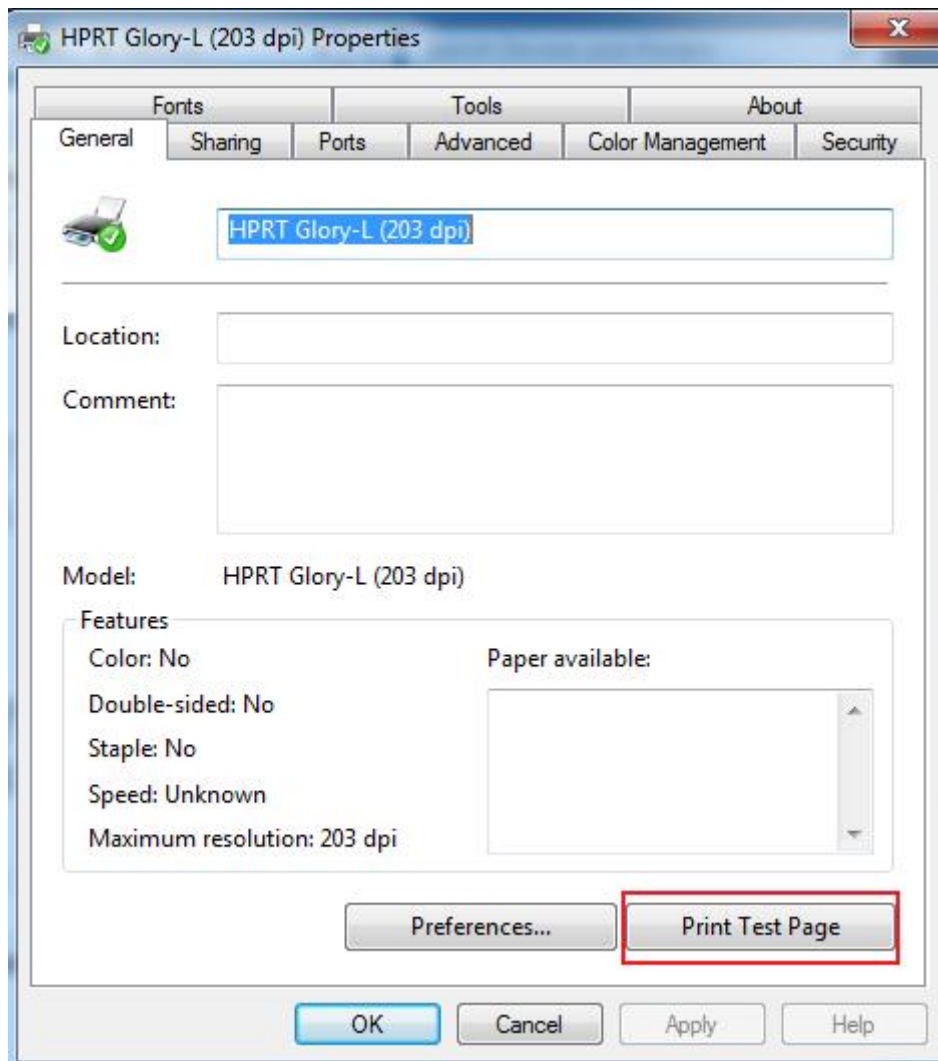

3. Click "Ports", and choose the port needed.

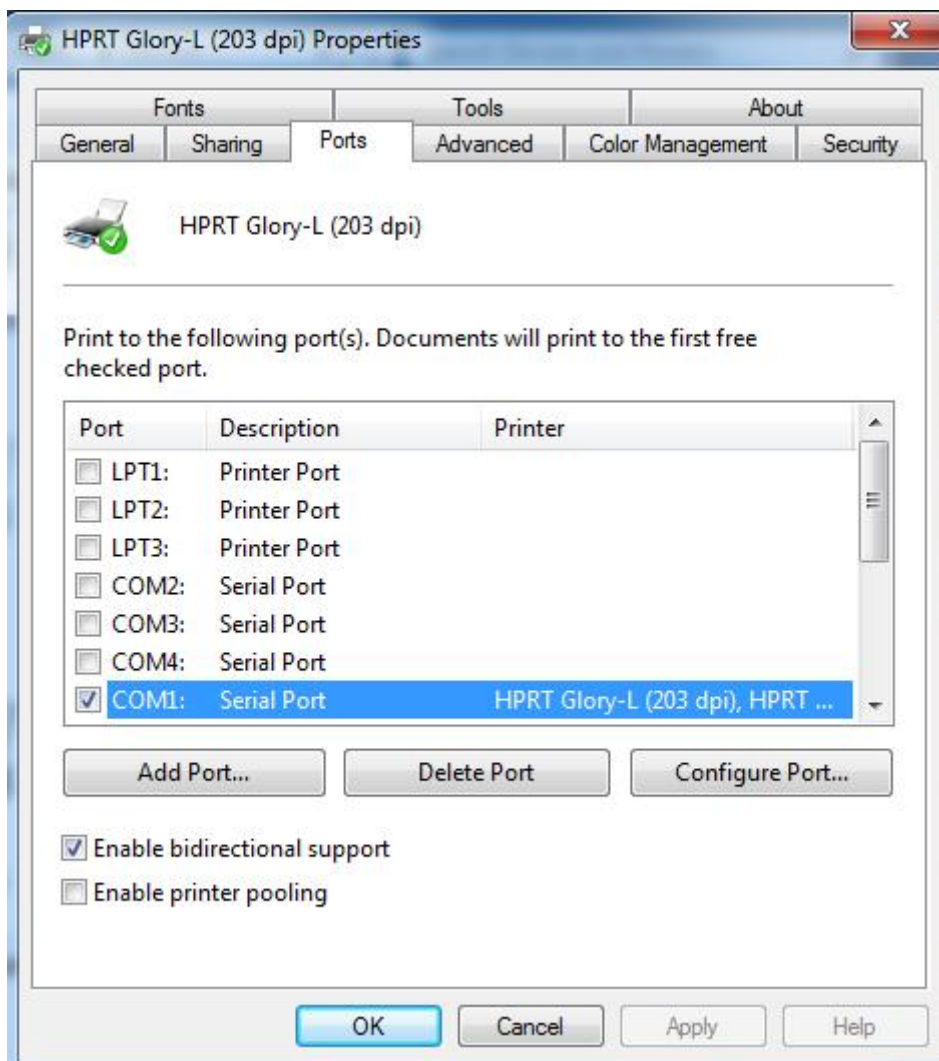

4. Click “Advanced” to set the available time for printer.

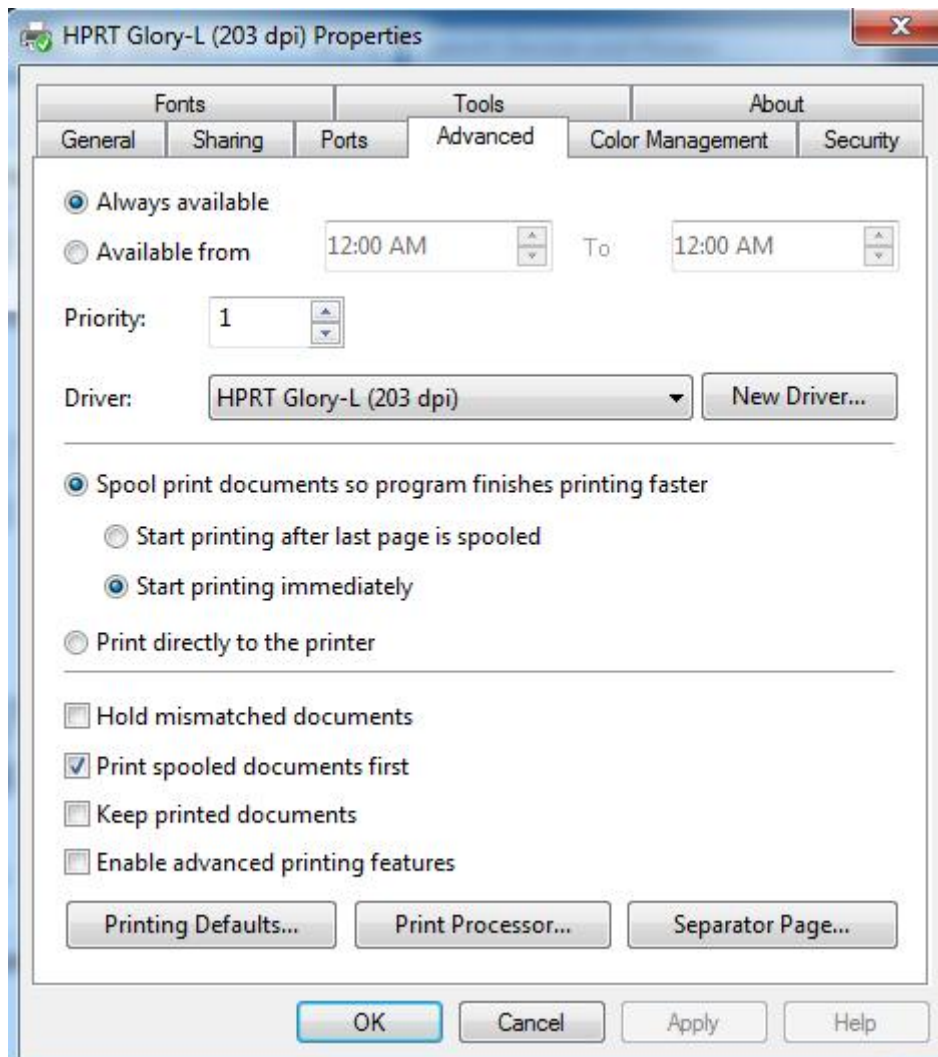

7.5 Removing



Note:

Please turn off the printer or unplug the USB cable before removing the driver.



1. Double click Seagull Windows Driver.
2. Read and agree the license agreement. Then click "Next".



3. Choose the installation directory, then click "Next".

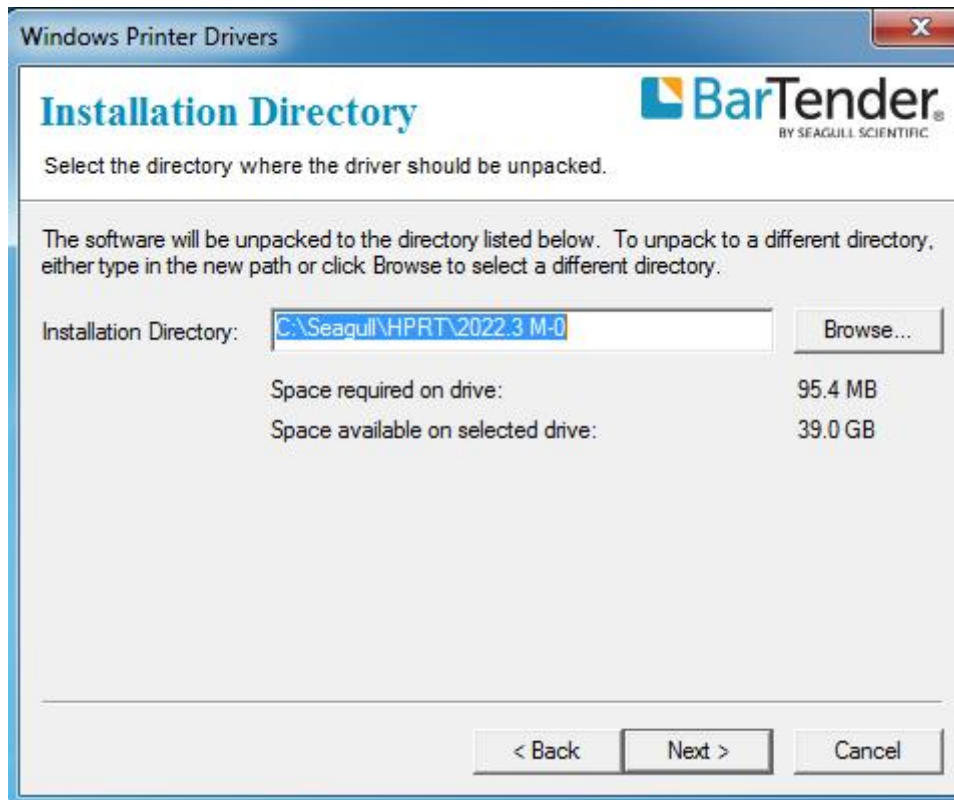

4. Click "Finish".

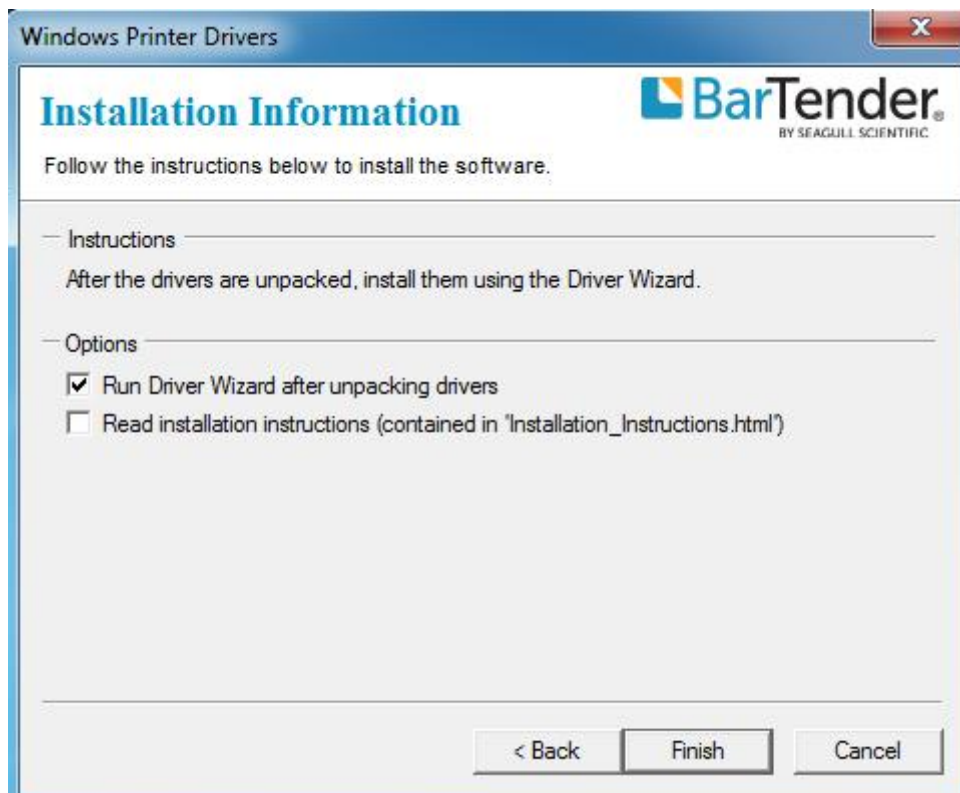

5. Select “Remove printer drivers”, then click “Next”.



6. Select “Remove printers”, then click “Next”.

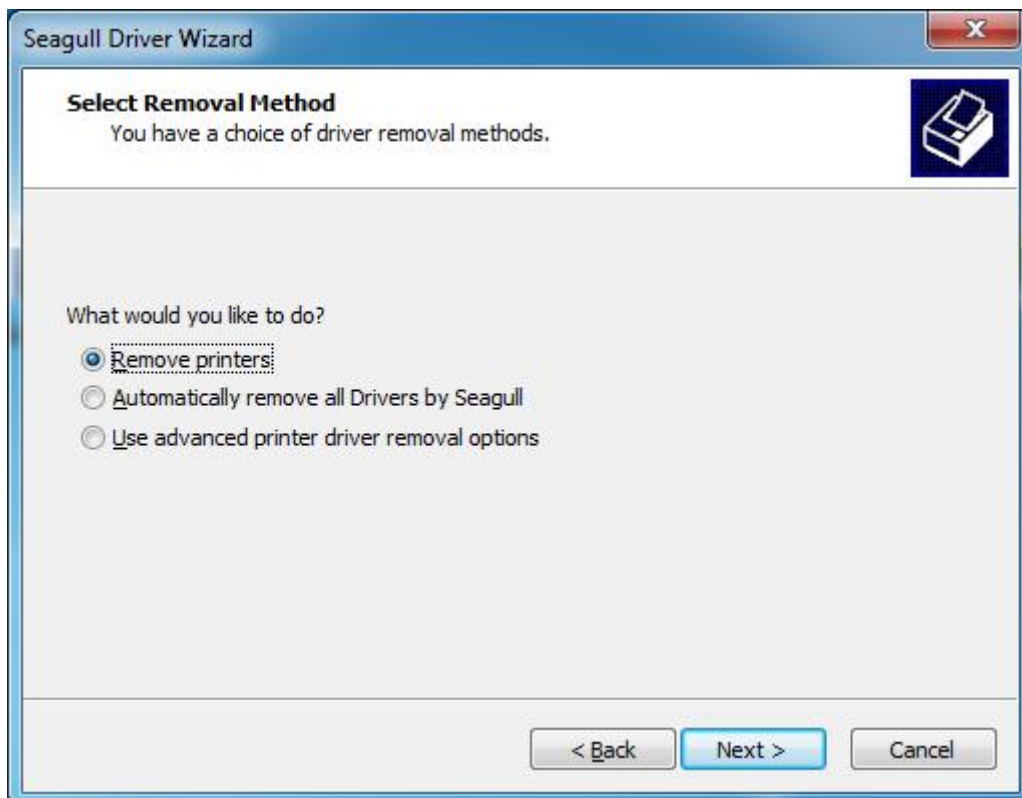

7. Select printer's name, then click "Next".

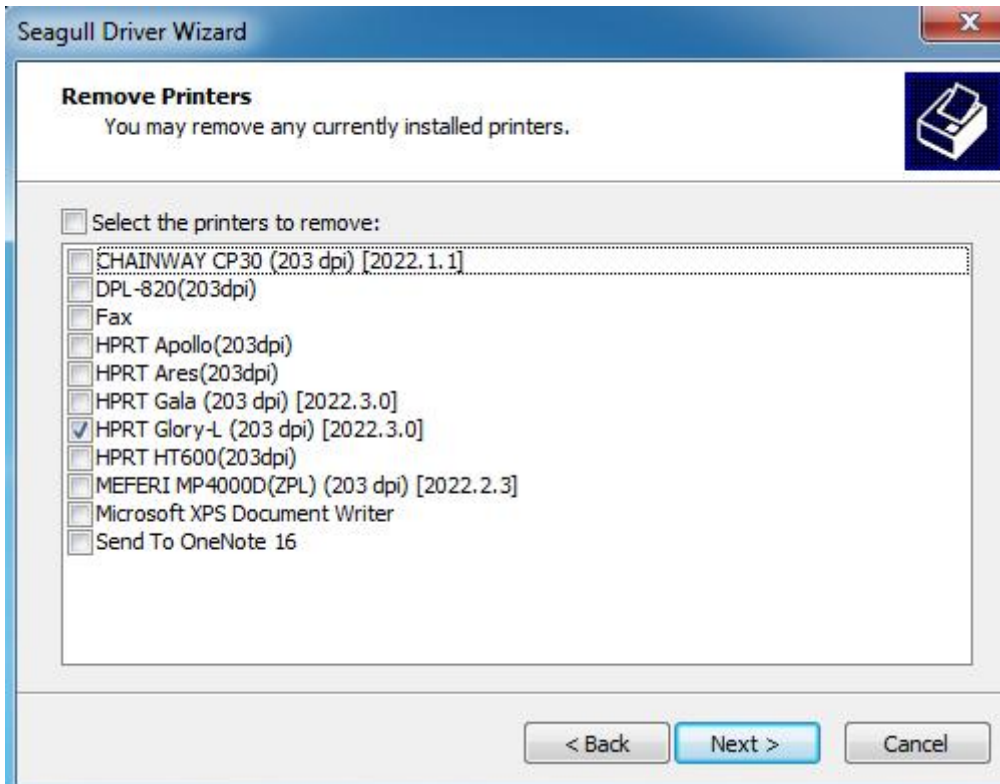

8. Please unplug the USB cable or turn off the printer when appearing the following prompt.

9. Click "Finish".

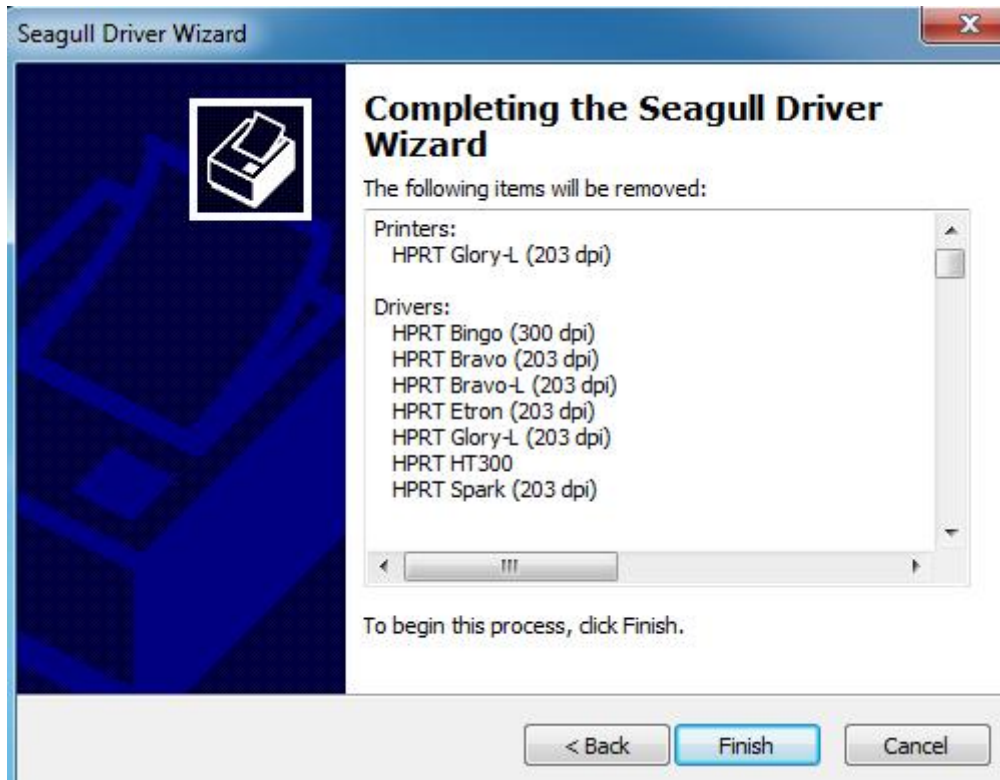

10.Restart the computer when appearing the following prompt, or continue step 11.

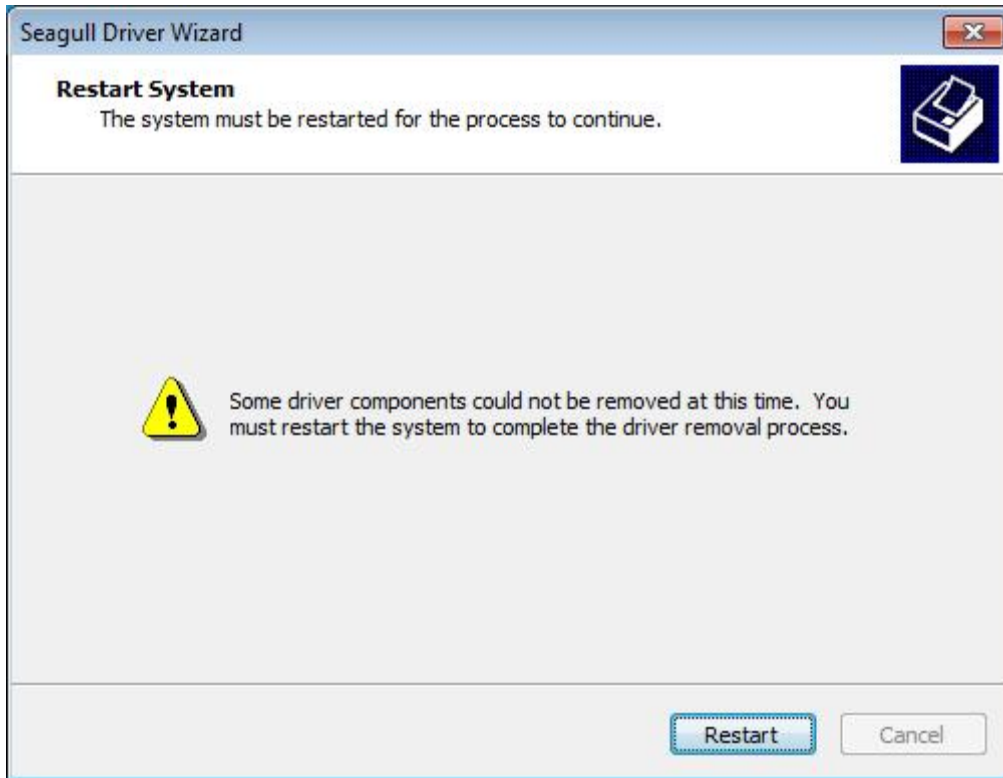

11.Click "Close". The driver has been removed successfully.

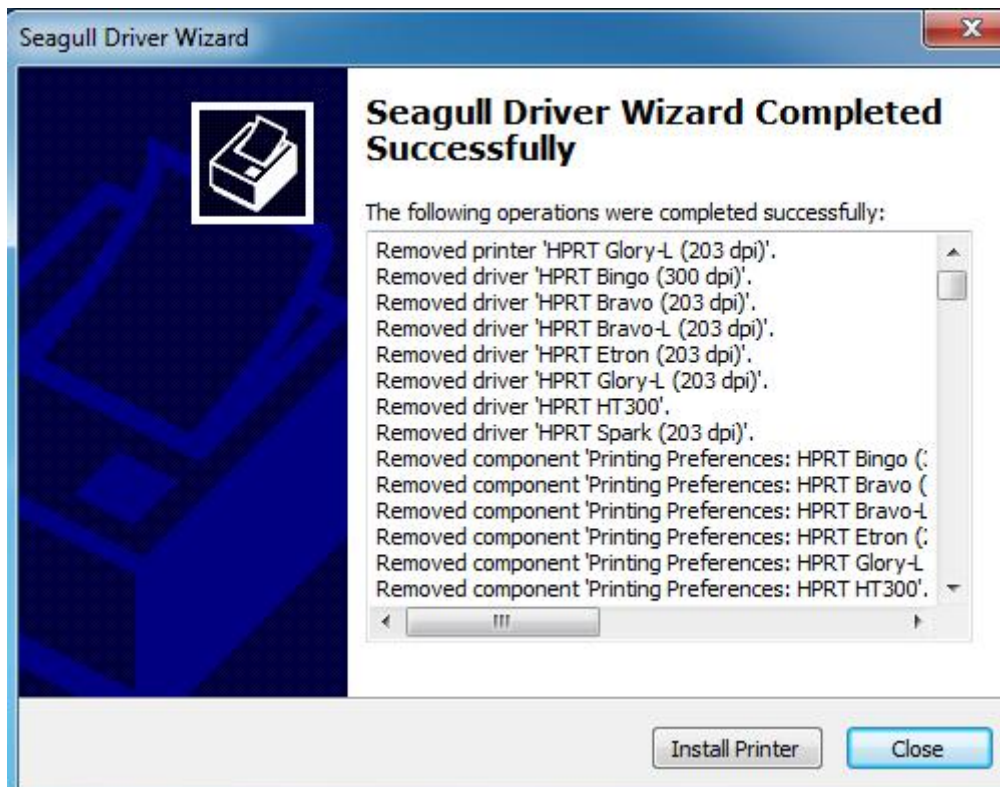

Chapter 8 BarTender UltraLite Instructions

8.1 Introduction

This chapter provides instructions on BarTender UltraLite program according to PC operating systems (OS).

The followings are supported.

- Windows 10, 8.1, 8, 7 and Vista.
- Windows Server 2016, Server 2012 and 2012 R2, Server 2008 and 2008 R2.
- Includes all 32-bit and 64-bit (x64) editions.

8.2 Installation Preparation

Download BarTender UltraLite application program in CD.

8.3 Installation



Note:

- Under different operating systems, the screen may be slightly different. Take Windows 7 as example.
- Take printer Bravo-L as example.
- To avoid the prevention, recommend to close the security software before installation.

1. Double click the application program .

2. Select language, then click "OK".



3. Click "Install".

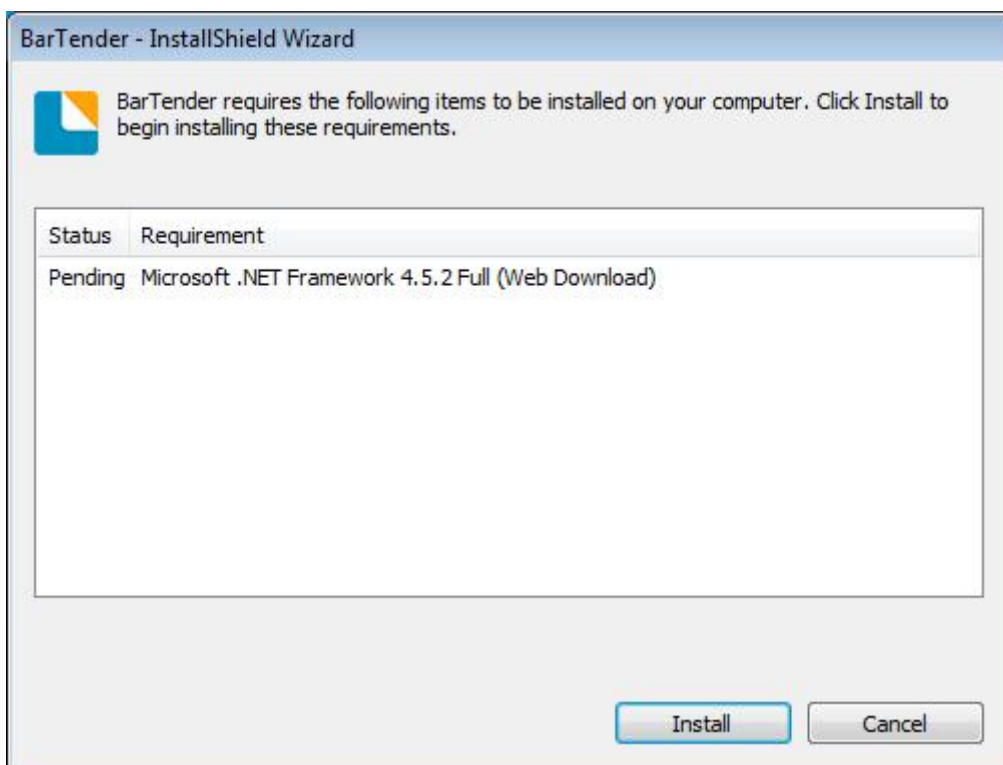

4. Click "Next".



5. Read and accept the license agreement, then click "Next".

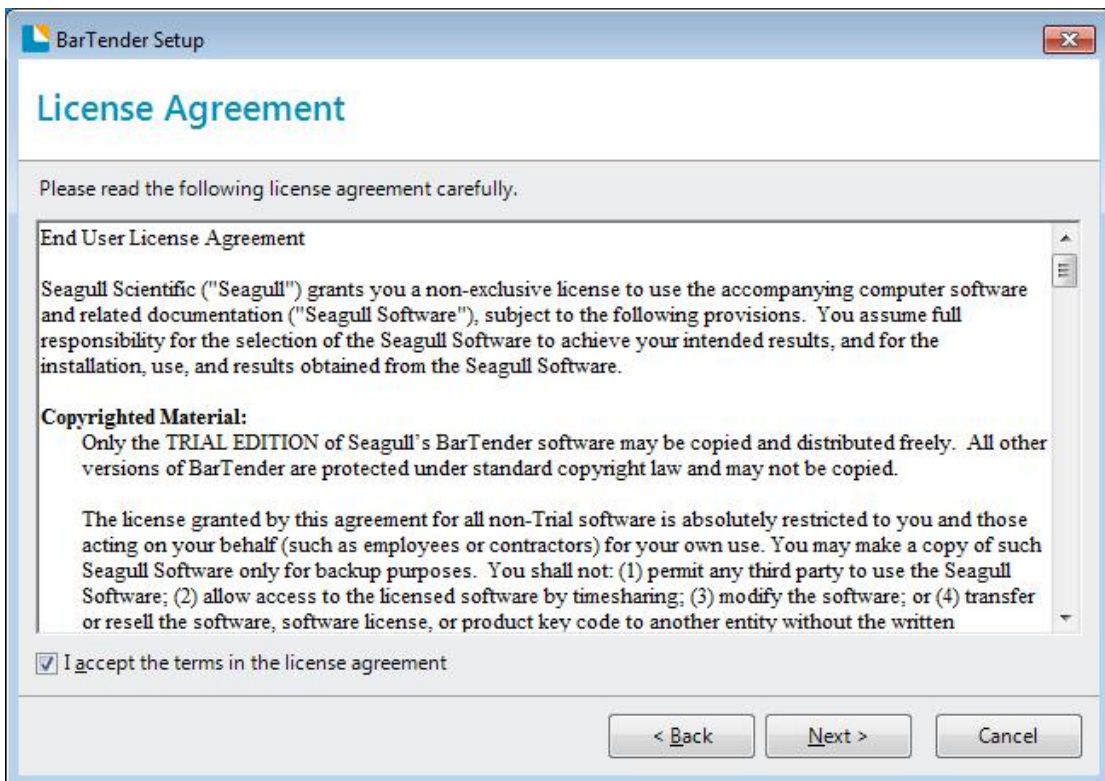

6. Select "Features" and installation location, then click "Next".

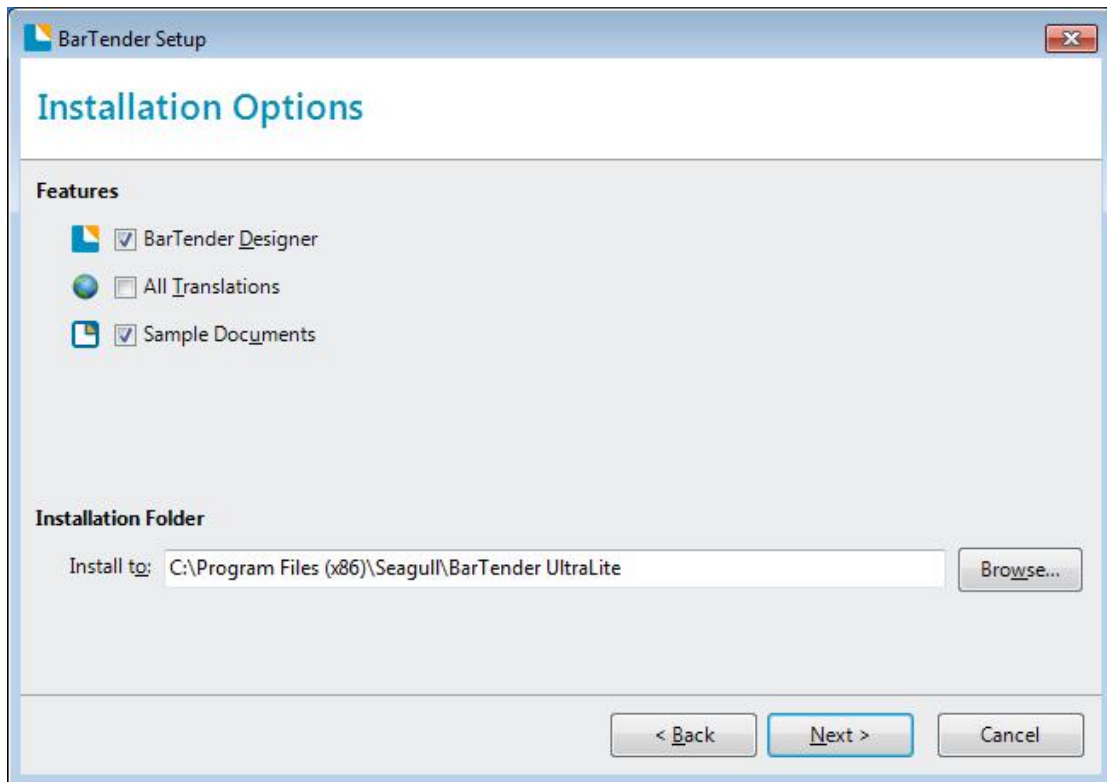

7. Click "Install".

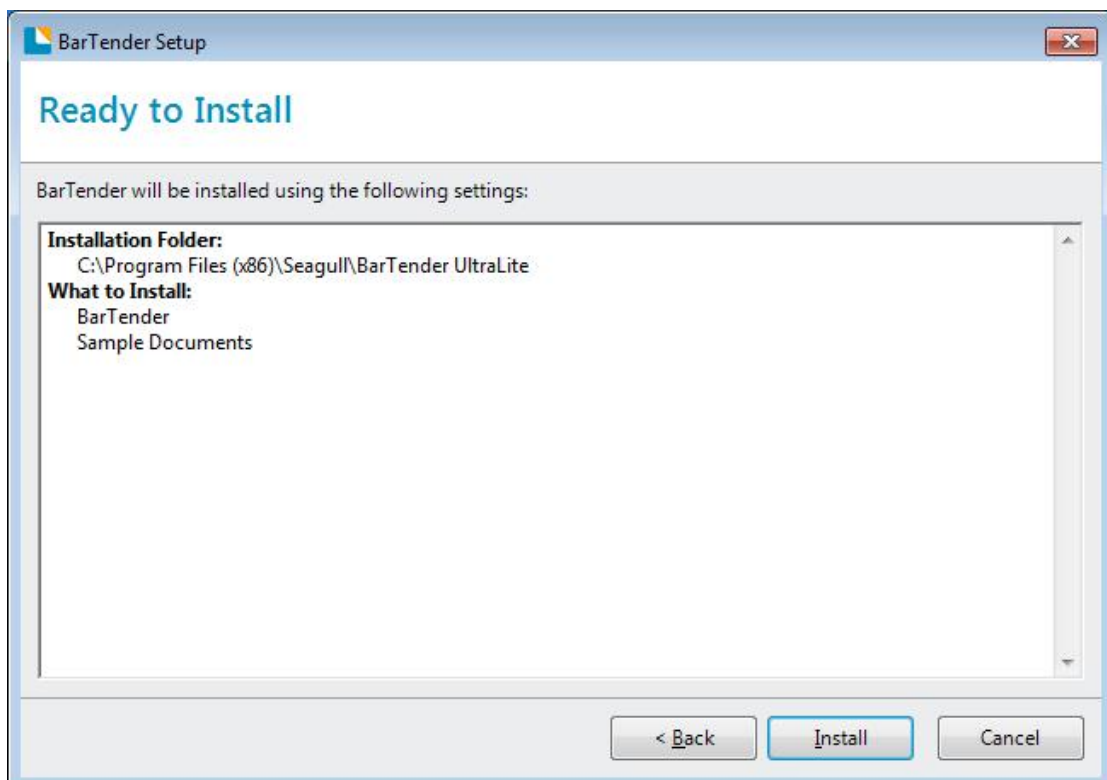

8. Click "Finish".

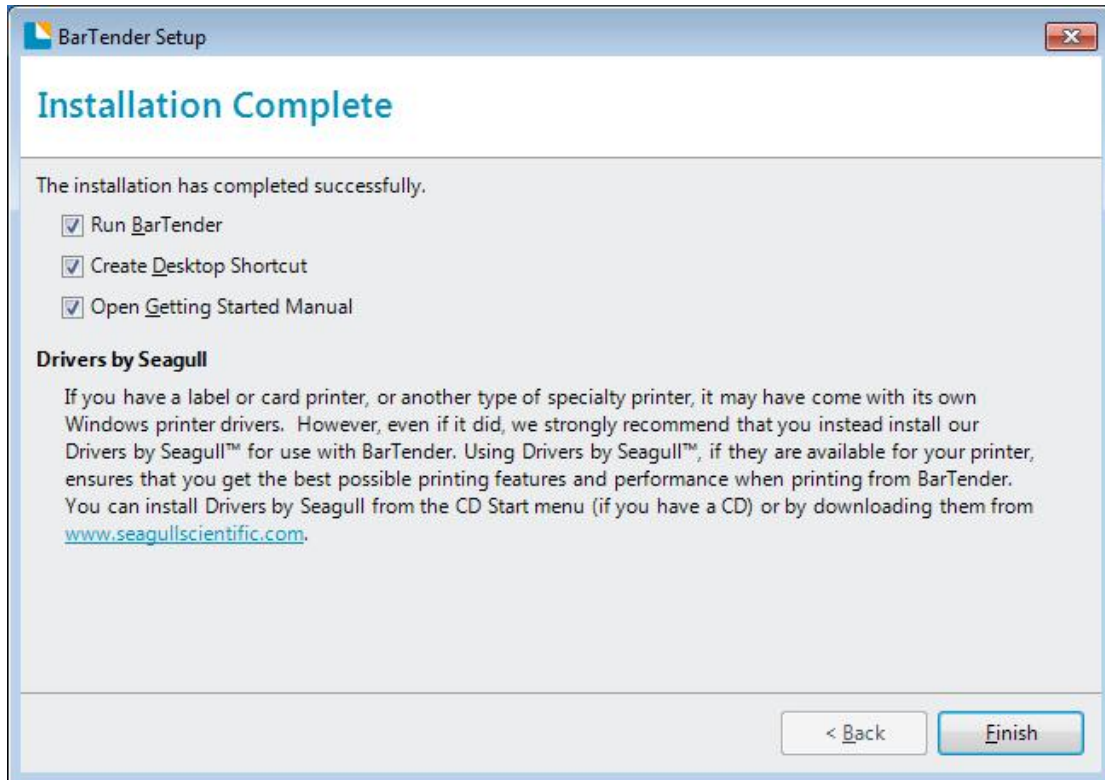

9. Back to desktop, and you will see the icon of BarTender UltraLite. Double click it and get down to use.



8.4 Usage

8.4.1 Page Settings

1. Double click the icon, then choose the edition. Click “OK”. (The edition may be changed according to different needs.)

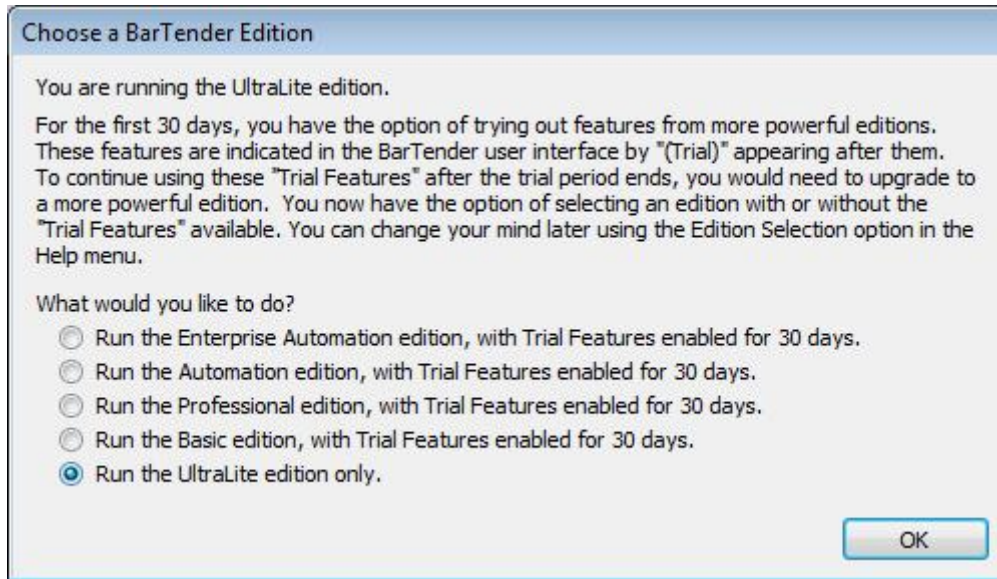

2. Click “Start a new BarTender document”.

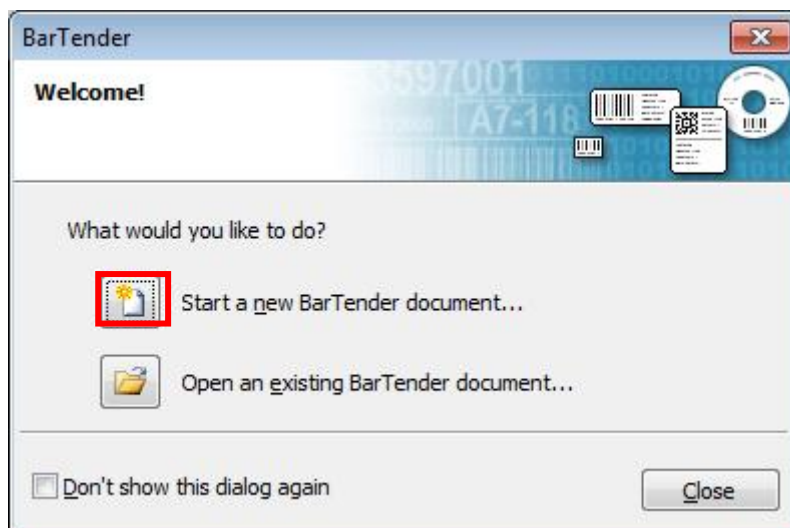

3. Choose “Blank Template”, then click “Next”.

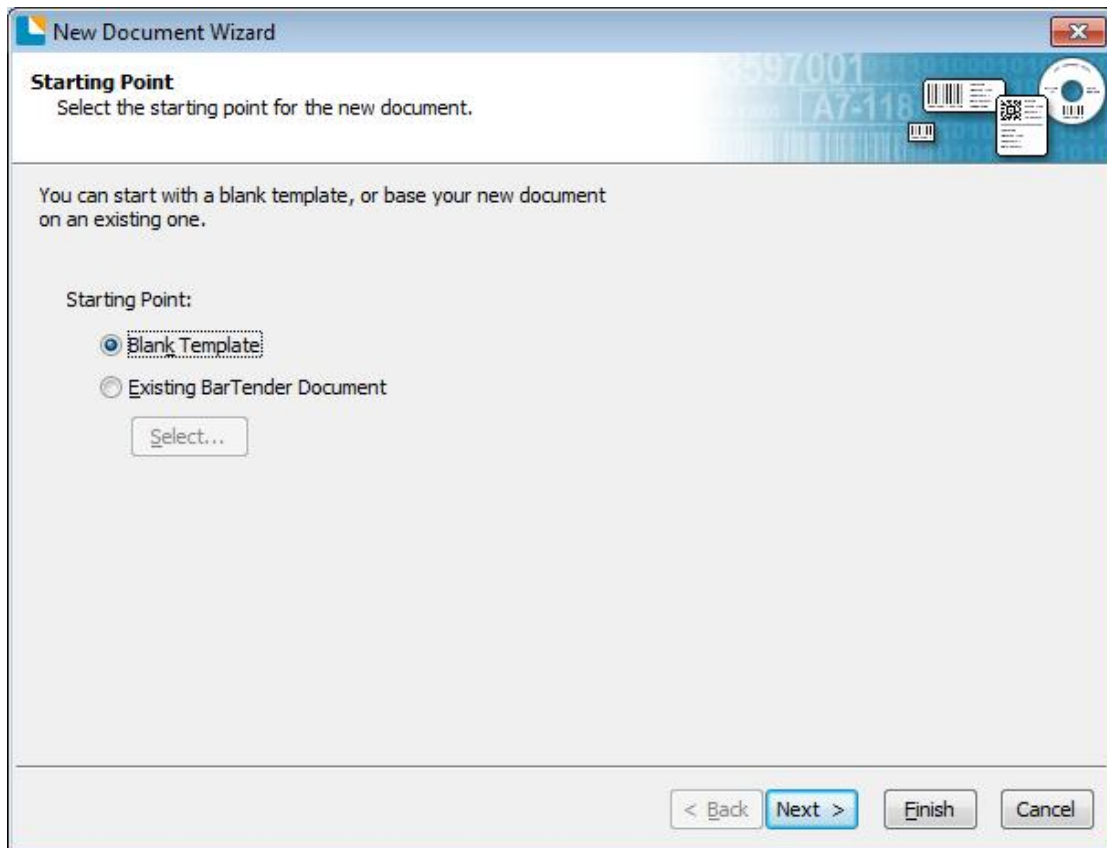

4.If the predefined stocks do not meet your need, tick “Specify Custom Settings”. Then click “Next”.

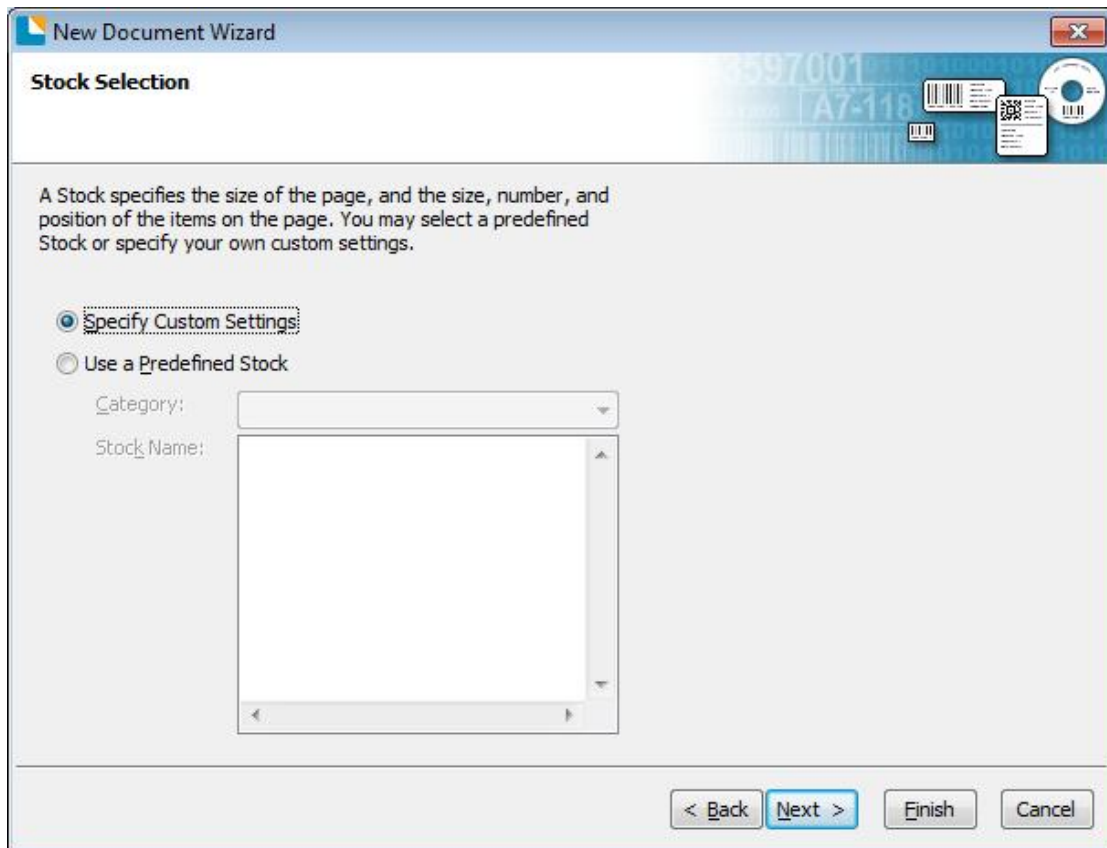

5. Tick “Single item per page”, then click “Next”. (If you print multiple labels, tick “Multiple columns and/or rows of items per page”.)

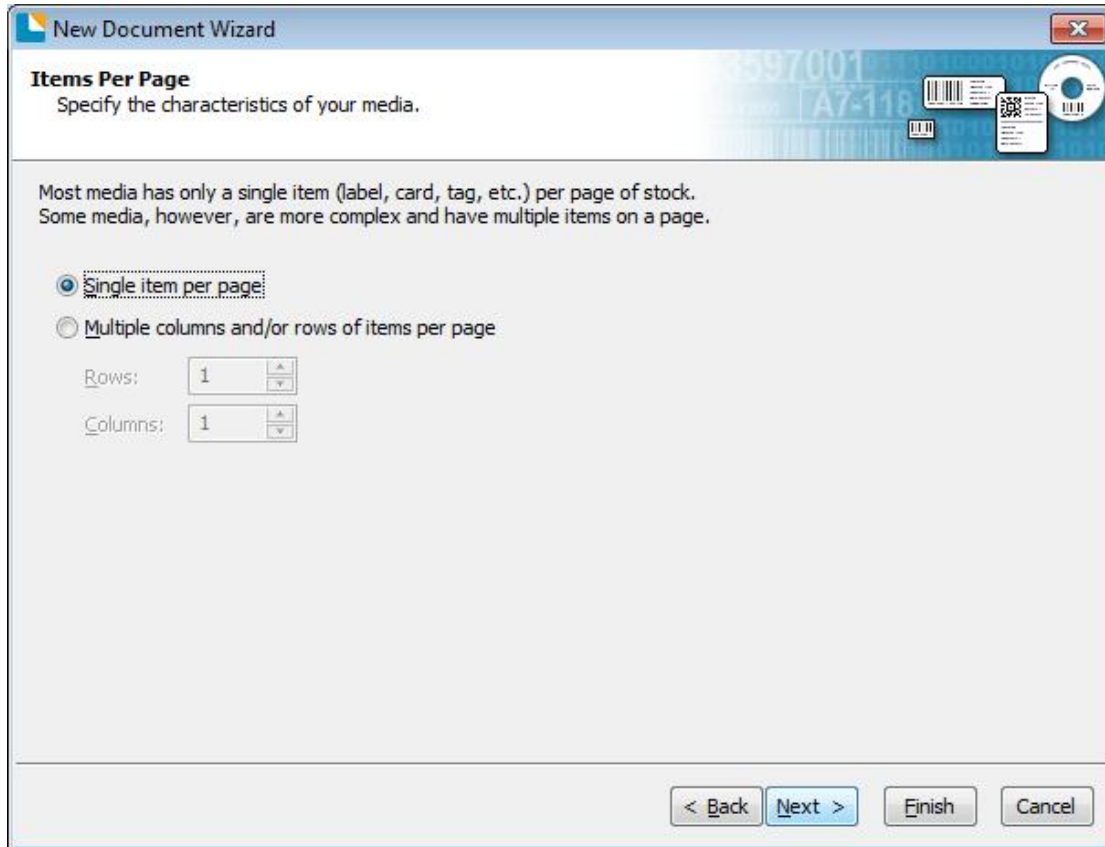

6. Edit the side edges, then click “Next”.

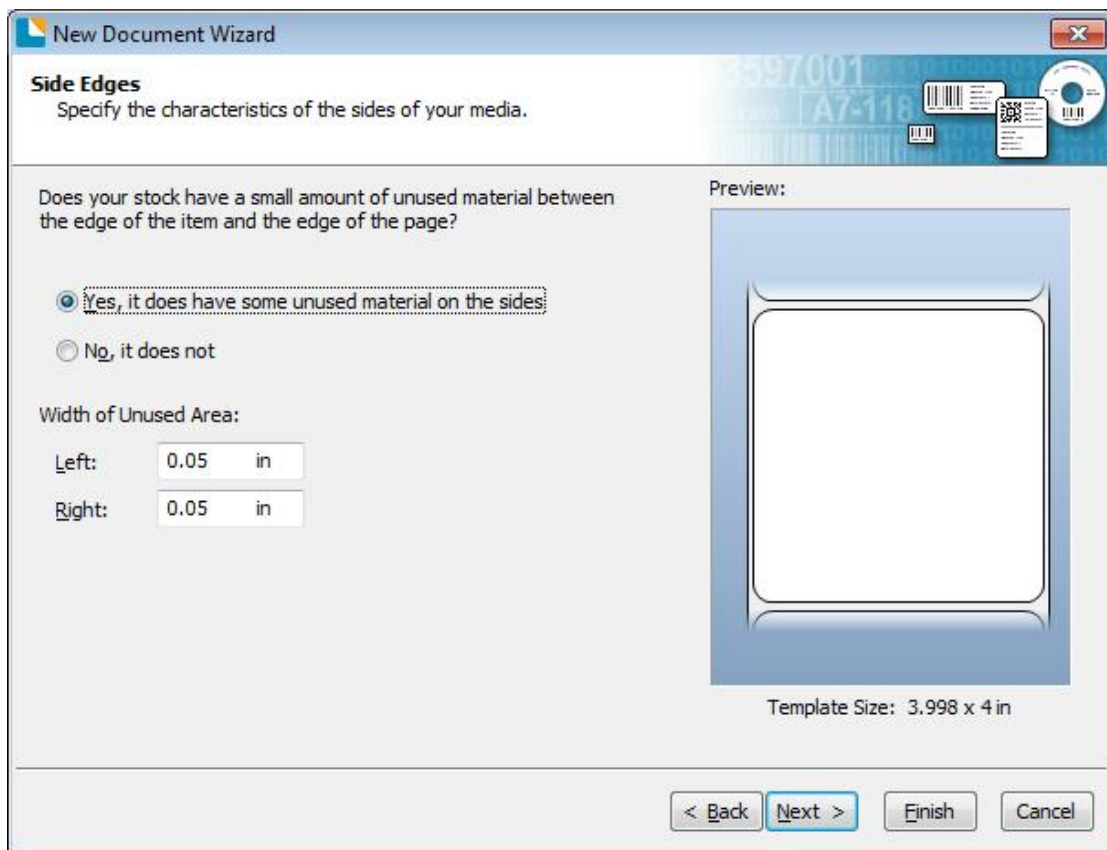

7. Choose the item shape, then click “Next”.

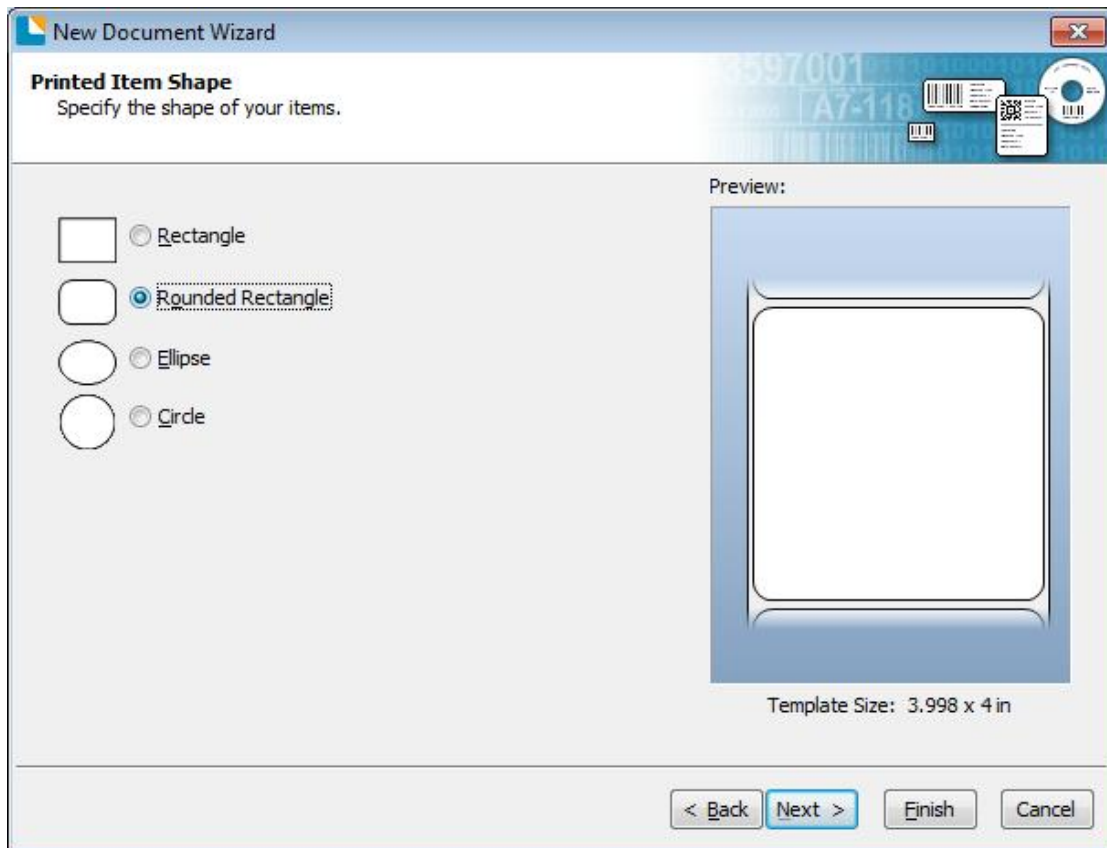

8. Edit the template size, then click “Next”.

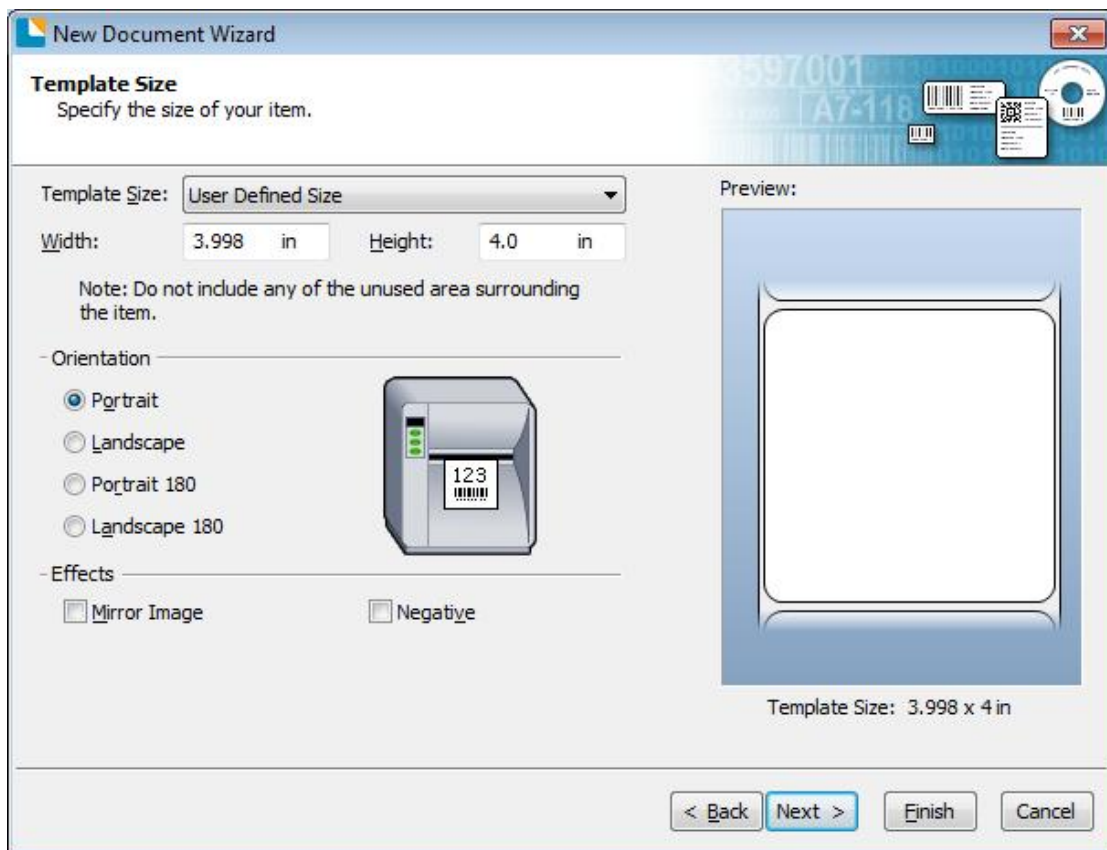

9. Based on your need, edit the template background. Then click “Next”.

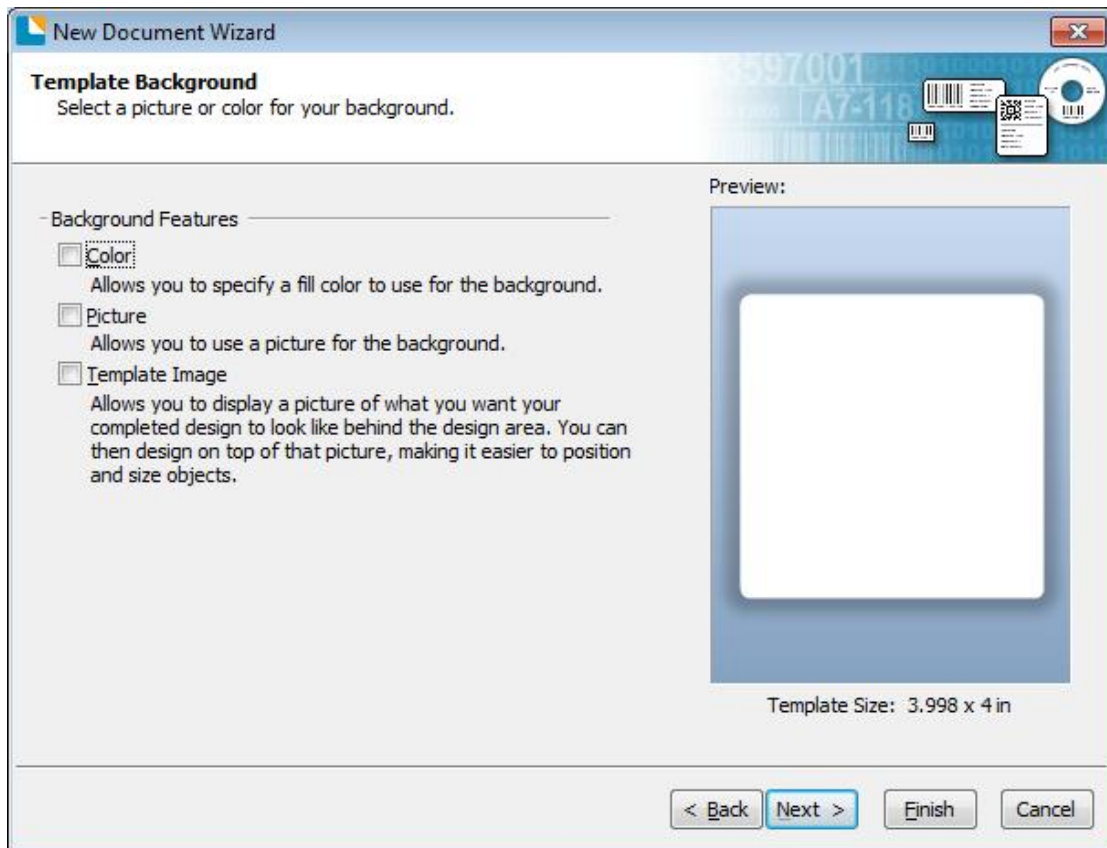

10. Finish the settings, showed in the “Review” and “Preview”. Then click “Finish”.

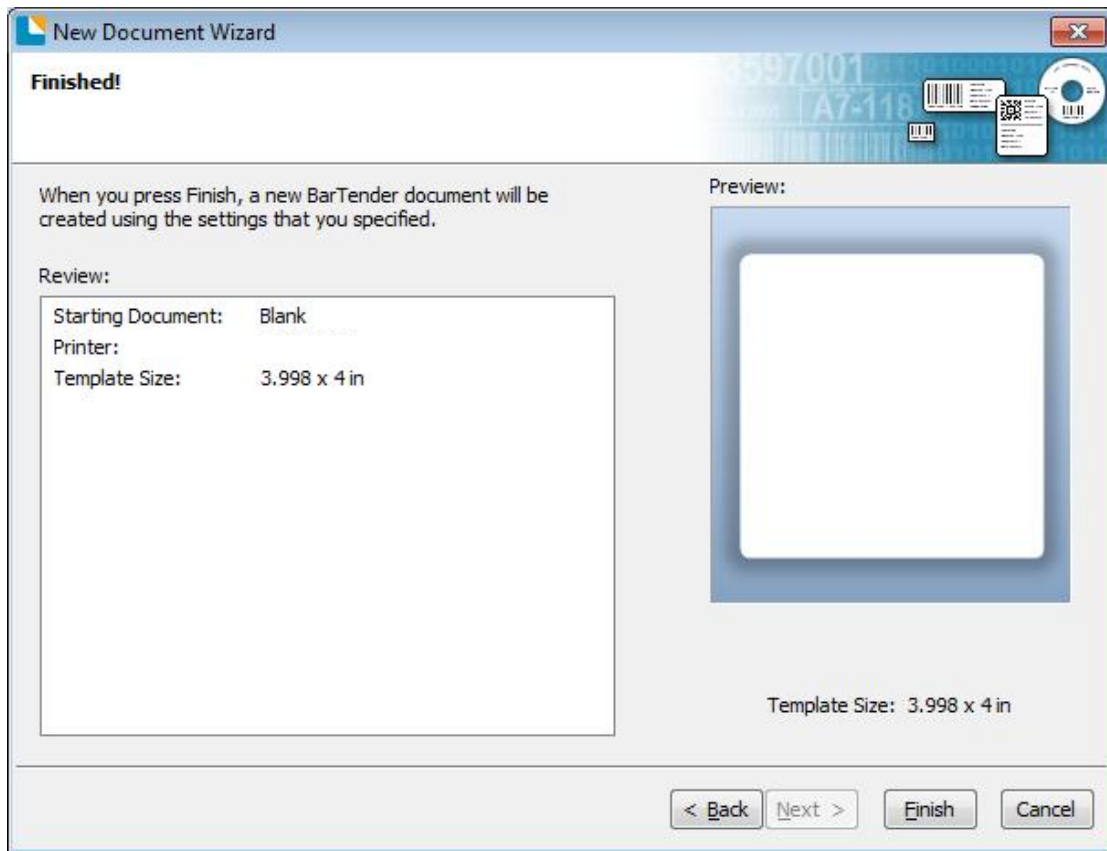

8.4.2 label Edit

1. Click the icon of code .
2. Choose the code, then click "Select".

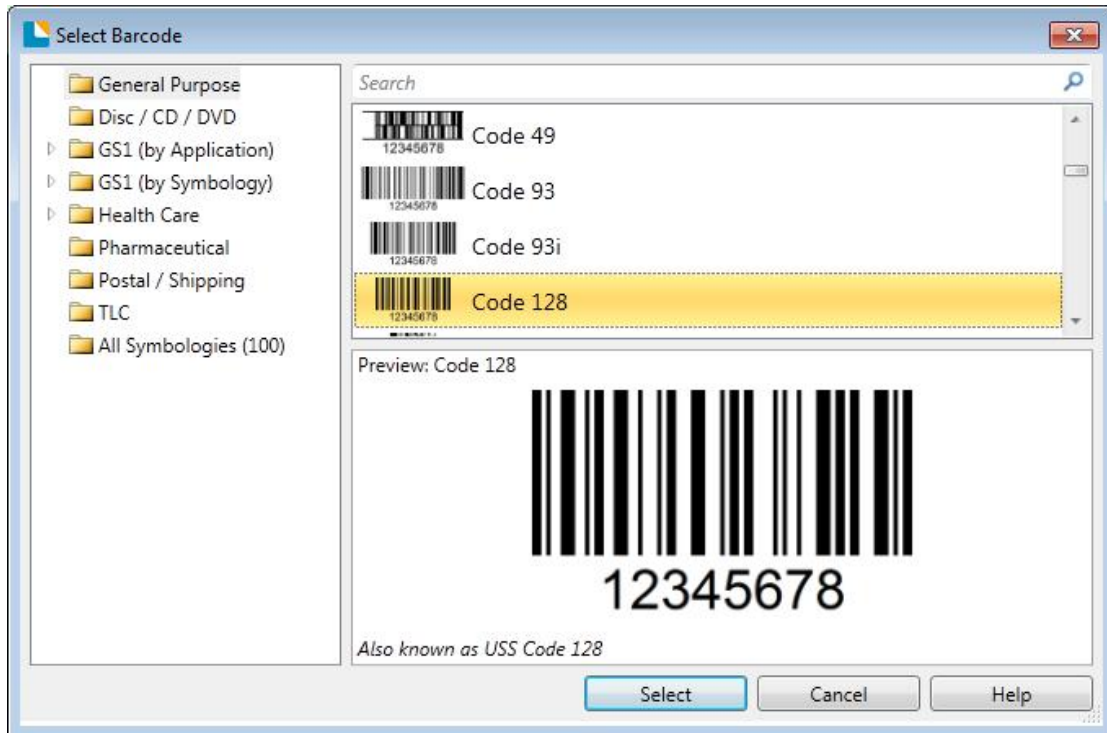

3. Click the blank, showing the code.

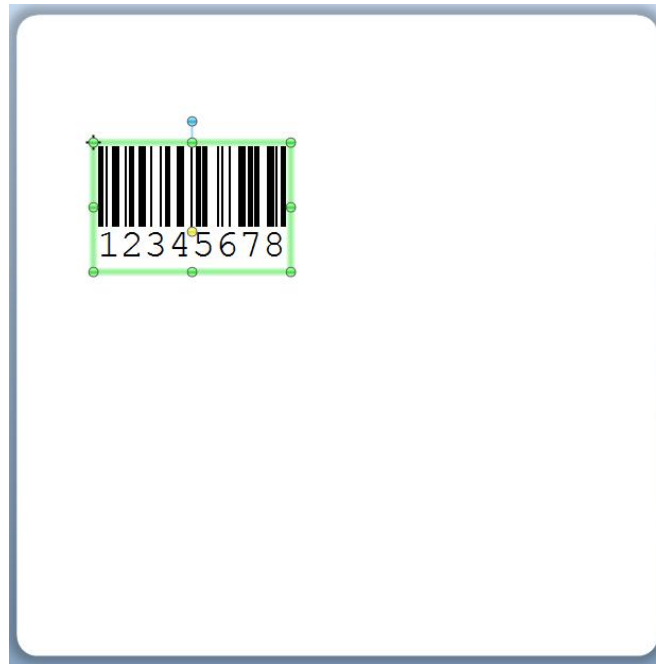

4. Double click the code and edit it. User can set up the size, font, border and so on.

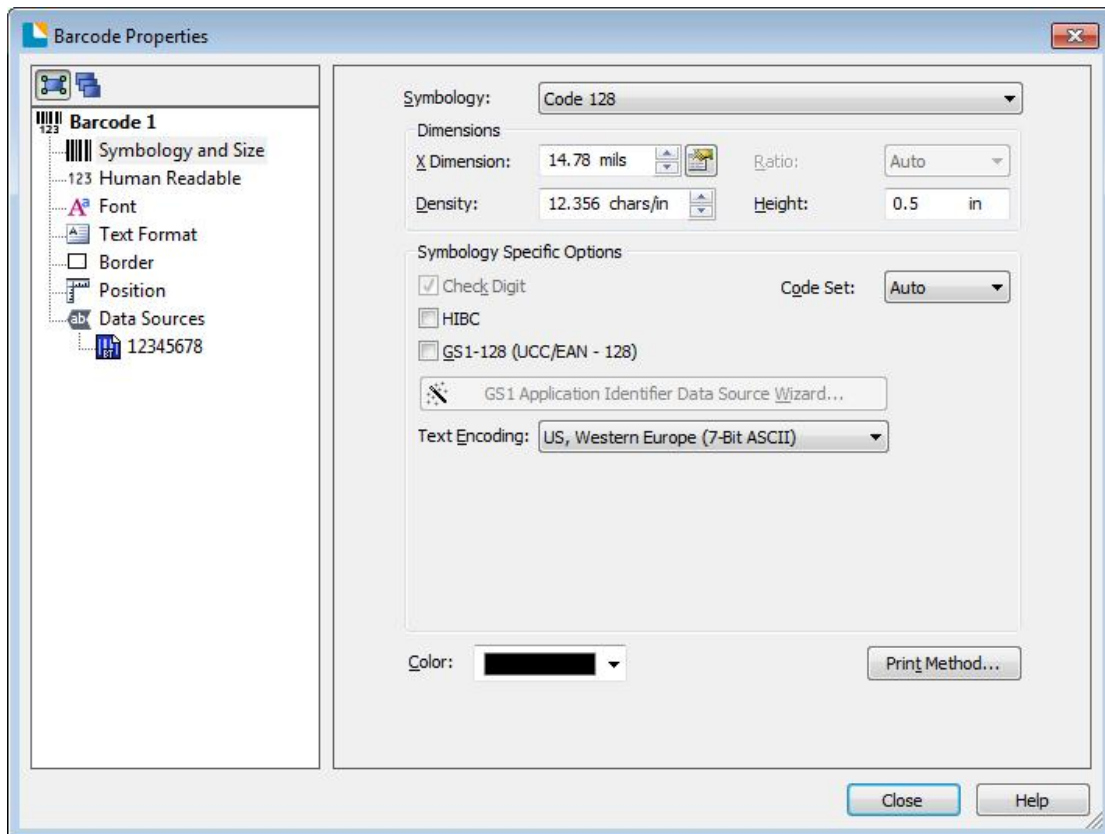

5. Click the icon of character , then enter the text.

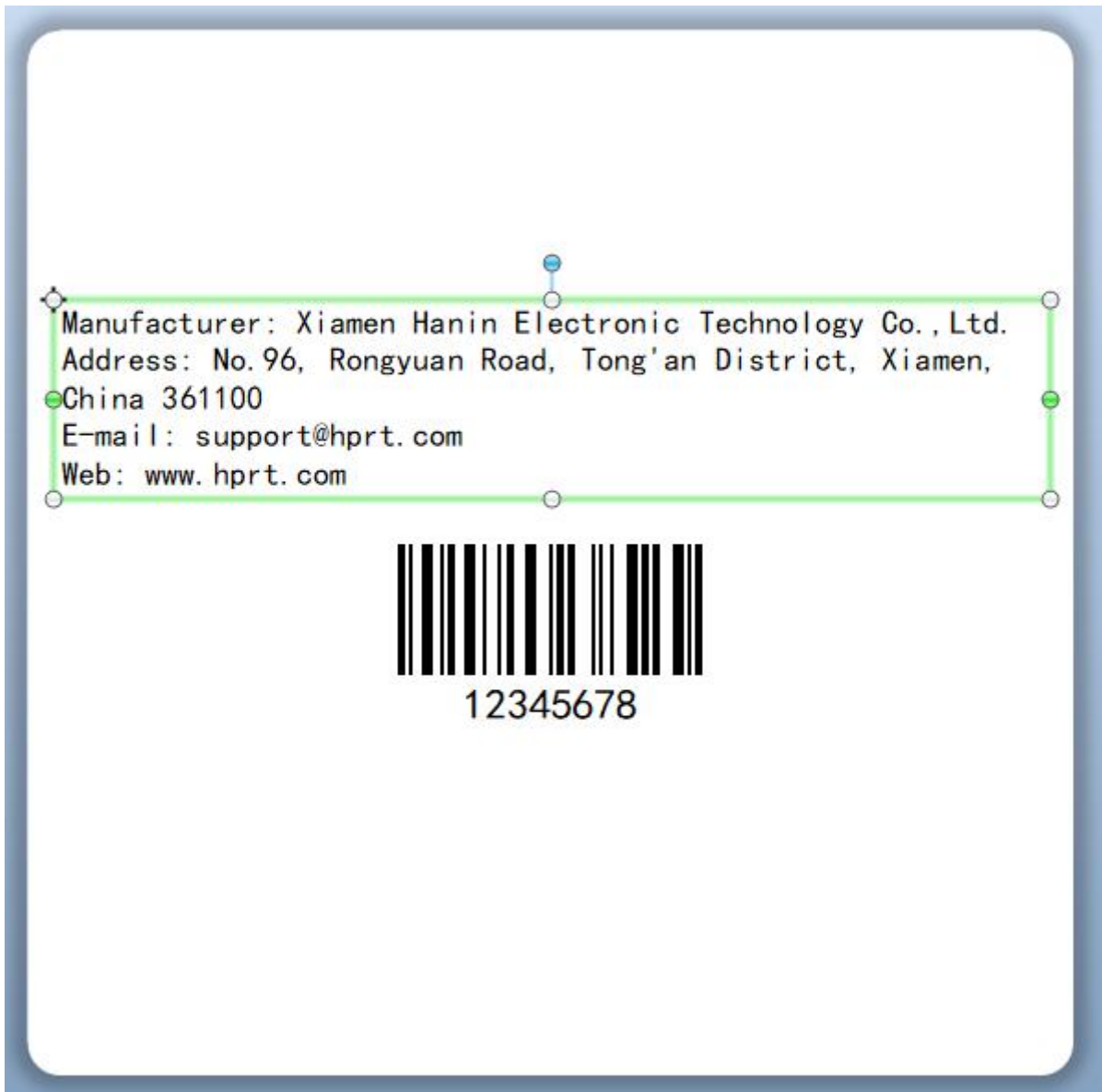

6. Click the icon of picture , then edit the pictures.

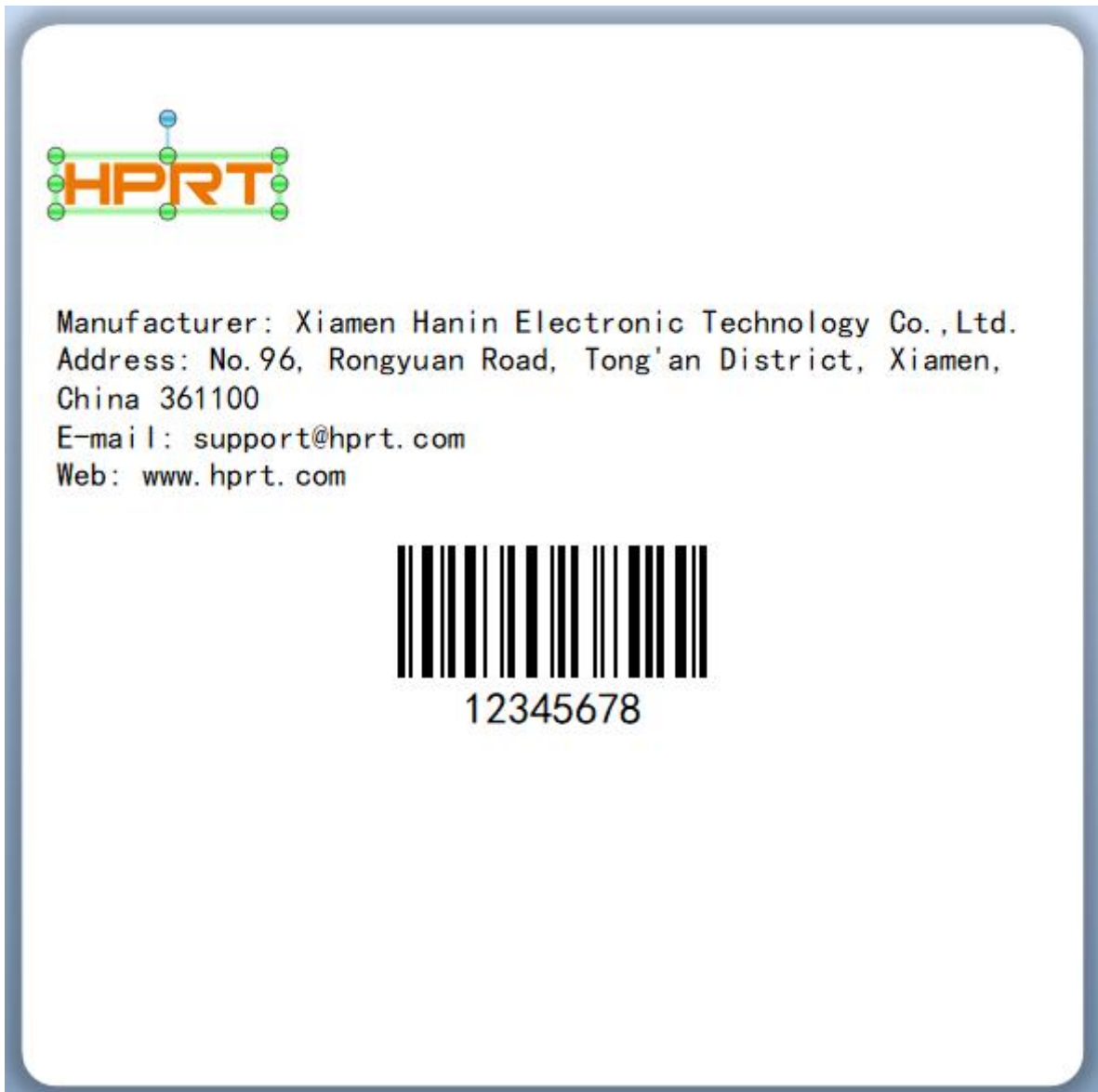



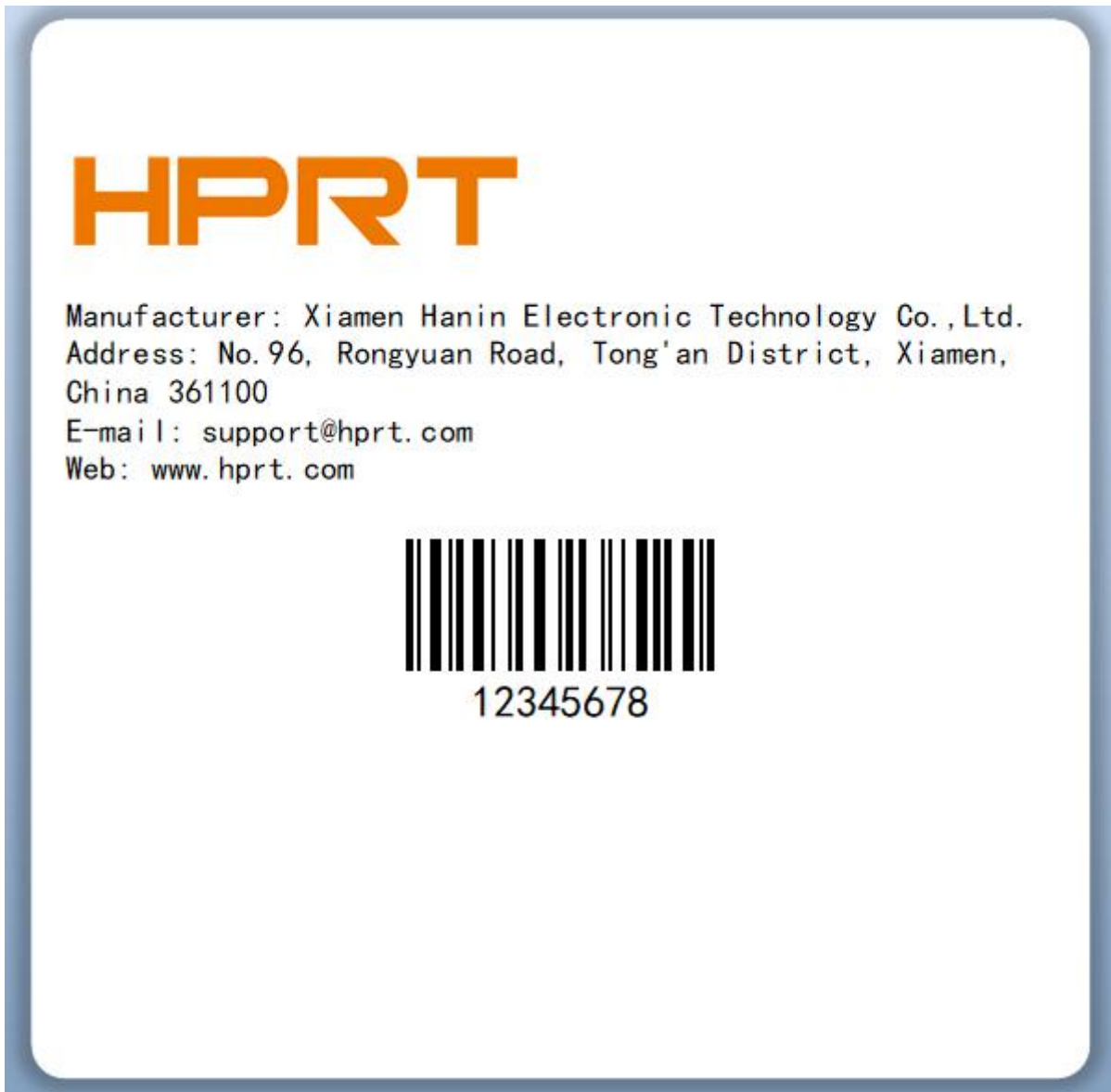



7. Compose the text.







8. Finish all the settings. Click "Print" and a new label will be printed.



Appendix I Display Menu

Main menu	Submenu	Parameter	Remark	
Setting 	Printing Setup 	Printing Method	0: DT 1: TT	Default: Factory settings (locked/unlocked))
		Printing Speed	2-N ips	Default: Factory settings N: Maximum depends on the language
		Printing Darkness	0-N ZPL/DPL/=30;EPL=20; TSPL=15	Default: Factory settings N: Maximum depends on the language
		Page Rotation	0: 0°, 1: 90° 2: 180°, 3: 270°	Default:0 (locked/unlocked)
		After Printed	0: None, 1: Tear 2: peeler, 3: Cutter	Default:1 (locked/unlocked)
		Stop Position	Position peel, tear and cutter position 0: Automatic default 1: manual 0 - 30.0 mm	Default: Tear paper line position based on print line (locked/unlocked)
	Advance 	Label type	gap label (default), black label, continuous paper	Default:0 (locked/unlocked)
		Position	Automatic (default) penetration detection Reflective detection	Default:0 (locked/unlocked)
		Print Y offset	Adjust the vertical coordinates of the print start position + /- 120 dots	Default:0 (locked/unlocked)
		Print X offset	Adjust the horizontal start of the print + /- 120 dots	Default:0 (locked/unlocked)
		PL Simulation	Automatic or manual lying 0: Automatic recognition switch 1: ZPL 2: TSPL 3: EPL 4: DPL	Default:0 (locked/unlocked)



Main menu	Submenu	Parameter	Remark	
Setting 	Advance 	Codepage	0: CP850	
			1: CP852	
			2: CP437	
			3: CP860	
			4: CP863	
			5: CP865	
			6: CP857	
			7: CP861	
			8: CP862	
			9: CP855	Default:0 (locked/unlocked)
			10: CP866	
			11: CP737	
			12: CP851	
			13: CP869	
			14: Win 1252	
			15: Win 1250	
			16: Win 1251	
			17: Win 1253	
			18: Win 1254	
LCD Language 	LCD Timeout	0: No	Default:1	
		1: 10s-9: 90s		
	LCD Brightness	0-9	Default:4	

Main menu	Submenu	Parameter	Remark	
Setting 	LCD Language 	LCD Language 0: English 1: Español 2: Português 3: Français 4: Deutsch 5: Русская 6: Japanese 7: 한국의 8: Simplified Chinese 9: Traditional Chinese	Default:0 9: Downloadable changes	
		LCD Password NNNN	Default:0000 N: 0-9 NNNN: 0000 indicates no password functionality	
		Standby Display 0: Display Ready 1: Display date and time	Default:0	
	Port setting 	RS232 Setting	Baud Rate 0: 9600, 1: 14400, 2: 19200, 3: 38400, 4: 57600, 5: 115200 Default:0	
			Data Bits 0: 7-bit, 1: 8-bit Default:0	
			Parity Check 0: None, 1: Odd, 2: Even	
			Flow Control 0: None, 1: XON/XOFF, 2: Hardware, 1.SW+HW Default:2	





Main menu	Submenu	Parameter	Remark
Setting 	Port setting 	Ethernet Switch 0: OFF 1: ON Default: Factory settings	
		Address Mode 0: DHCP 1: Static Default:1	
		IP Address NNN.NNN.NNN.NNN Default:192.168.1.1 N: 0-9; NNN: 0-255	
		Default Gateway NNN.NNN.NNN.NNN Default:192.168.1.0 N: 0-9; NNN: 0-255	
		Subnet Mask NNN.NNN.NNN.NNN Default: 255.255.255.0 N: 0-9; NNN: 0-255	
		Port Number NNNNN Default:9100 N: 0-9	
		WiFi Switch 0: OFF; 1: ON Default:0	
	Networking Mode 0: AP mode 1: Station mode Default:0		
	WiFi Setting SSID Alphanumeric character AP Default: Printer model		







Main menu	Submenu	Parameter	Remark
Setting 	External Device Setting 	Keyboard Connect port 0: No 1: USB Host (Automatic connection) 2: Serial port	Default:0
		Ext. Keyboard Language 0: English 1: Español 2: Português 3: Français 4: Deutsch 5: Русская	Default:0
		Barcode Scanner Connect port 0: No 1: USB Host (Automatic connection) 2: Serial port	Default:0
Maintain and Test 	TPH printed mileage	Show printer print miles 0-99999.99 meters	No blank paper miles
	TPH bad dot printing test	Print test sheet	
	TPH bad dot scan	Abnormal scanning test of impedance of print head	Tested, total return bad points
	Label Calibration	Label learning and correction	Action completion will stop in the corresponding stop position according to the setting of the tearing/peeling/cutting



Main menu	Submenu	Parameter	Remark
Maintain and Test 	Media sensor printing	Signal quantitative waveforms detected by print media	Detection according to specified sensor mode
	Dump mode	Print the received data and automatically change lines when the width of the label exceeds	Press feed key back to standby
	Cutting test	Test the cutter function	Errors will be reported
	Restore factory default	Is there a need to restore Factor sets? Y/N 0: NO 1: YES, Files that have been downloaded and stored will also be retained and not cleaned up	Default: 0
	Firmware update	Automatically list firmware files, select files and confirm whether to read the firmware specified in the U disk for updates? 0: Printer firmware 1: Display Firmware 2: Display Picture Pack 3: Display screen specific page	Default: 0
Touch screen calibration	Five-point calibration at four corners plus center points		

Main menu	Submenu	Parameter	Remark
	Configuration 	Printer settings information	Print out the current printer settings information
		Built-in glyph list	Print out all built-in glyph models
		built-in barcodes list	Print out all barcode models
		List of user flash files	Print a list of user flash files
		List of user memory files	Print a list of user memory files
Advance 	Smart Printing 	External USB disk	Reformat 0: NO 1: YES Default: 0
		File Management	List display/copy/delete/start label format printing on specified memory/picture/font/database/firmware I: \.. (Internal Flash) U: \HPRT\... (External USB Storage) Default: list
		Auto Form	The selected label format runs automatically after the printer is turned on 0: No 1: Yes Default: 0

Appendix II Warning





Problem	Solution
<p>Form is not found</p> 	<p>Check if the files are exactly stored in the memory device.</p>
<p>Image is not found</p> 	<p>Check if the image is exactly stored in the memory device.</p>
<p>Fonts is not found</p> 	<p>Check if the font is exactly stored in the memory device.</p>
<p>No F/W found</p> 	<p>Firmware files are not stored in the USB storage when updating the firmware.</p>
<p>No Battery Found</p> 	<p>Battery is not installed in the printer when setting time and date. Check if the battery power runs out or not installed well.</p>

Problem	Solution
<p>Password Error</p> 	<p>Wrong password is entered. Enter the correct password to modify the protected parameters.</p>
<p>USB storage Lock</p> 	<p>Printer cannot write the data to the USB storage. Unlock the USB storage.</p>
<p>No USB storage found</p> 	<p>There is no USB storage installed in printer when updating the printer. Check if the USB storage is well inserted in printer.</p>
<p>No Cutter Found</p> 	<p>Cutter is not installed on printer when execute the cutter test.</p>
<p>Ethernet Error</p> 	<p>Ethernet port is disconnecting.</p>
<p>Flash ROM Full</p> 	<p>Internal flash ROM is full. Delete un-necessary files to store the current files.</p>





Problem	Solution
<p>Found No Bluetooth</p> 	<p>There is no Bluetooth module installed in the printer.</p>
<p>Found No WiFi</p> 	<p>There is no WiFi module installed in the printer.</p>
<p>Material too thick</p> 	<p>Material is too thick or hard, cutter takes longer time to return the blade to the initial position after cut.</p>





Appendix III Icon Description





Icon / Status Description	Icon / Status Description
<p>Printing:</p>  <p>Printer is printing something.</p>	<p>Wait label taken:</p>  <p>Wait to peel the printed label to print the next label.</p>
<p>Feeding:</p>  <p>Feeding the Label.</p>	<p>Wait on Demand:</p>  <p>Wait to press the feed button print the next label.</p>
<p>Cancel Printing:</p>  <p>Cancel the current printing job.</p>	<p>Saved:</p>  <p>Save the change of parameters to printer.</p>
<p>Pause Printing:</p>  <p>Pause the current printing job</p>	<p>Dump Data printing:</p>  <p>Catch the data from communication port and send to printer to print out. s</p>

Icon / Status Description	Icon / Status Description
<p>Media Calibration:</p>  <p>Press the feed button to calibrate the label.</p>	<p>Receiving Data:</p>  <p>As soon as all the data has been received, the printer will automatically resume operation.</p>
<p>Reboot firmware:</p>  <p>Restart printer.</p>	<p>Formatting USB mass storage:</p>  <p>Printer is creating the needed folders and control files to the USB mass storage.</p>

Appendix IV Trouble Shooting

Error	Resolution
<p>Found no Gap:</p> 	<ol style="list-style-type: none"> 1.Ensure the see-through sensor type is selected correctly. 2.Adjust the media sensor box to correct position. 3. Clean the receiver sensor and emitter sensor. 4. Ensure the label gap size is not out of from 2mm to 15mm. 5. Use “Media Sensor Printing” to verify the sensing signal from the media.
<p>Found no Black Mark:</p> 	<ol style="list-style-type: none"> 1.Ensure the reflective sensor type is selected correctly 2.Adjust the media sensor box to correct position 3.Black Mark height range: 3mm-30mm. Width minimum 10mm 4.Use “Media Sensor Printing” to verify the sensing signal from the media
<p>Paper Out:</p> 	<p>Reload new media roll.</p>
 <p>Ribbon Out:</p>	<p>Reload new ribbon roll.</p>
<p>Ribbon Steady:</p> 	<p>Remove the ribbon or configure the printer for thermal transfer media.</p>

Error	Resolution
<p>Print Head Open:</p> 	<p>Close the printer cover.</p>
<p>Firmware Update Fail:</p> 	<p>Re-update the firmware.</p>
<p>TPH Fail:</p> 	<p>Replace a new TPH.</p>
<p>Command Error:</p> 	<p>Press Feed key to clear this error, and make sure the next input commands are supported by the printer.</p>
<p>Cutter Jam:</p> 	<p>Check if labels stick in cutter and then clear up the adhesive from cutter blade.</p>

Error	Resolution
<p>Print Head is over-heat:</p> 	<p>Just wait for the TPH cool down and then continue printing automatically.</p>
<p>Write error:</p> 	<p>Ensure the mass storage is installed and formatted properly.</p>
<p>Write protected :</p> 	<p>Ensure the write protection is disable from the mass storage.</p>
<p>Paper Jam:</p> 	<p>Clear the jammed paper from the paper through path.</p>

Appendix V Download Path for Utility and Driver

1. Enter the website in browser: <http://www.hpvt.com>
2. Select the "DOWNLOAD" to get the Utility and Driver.