

POS80FE

User Manual

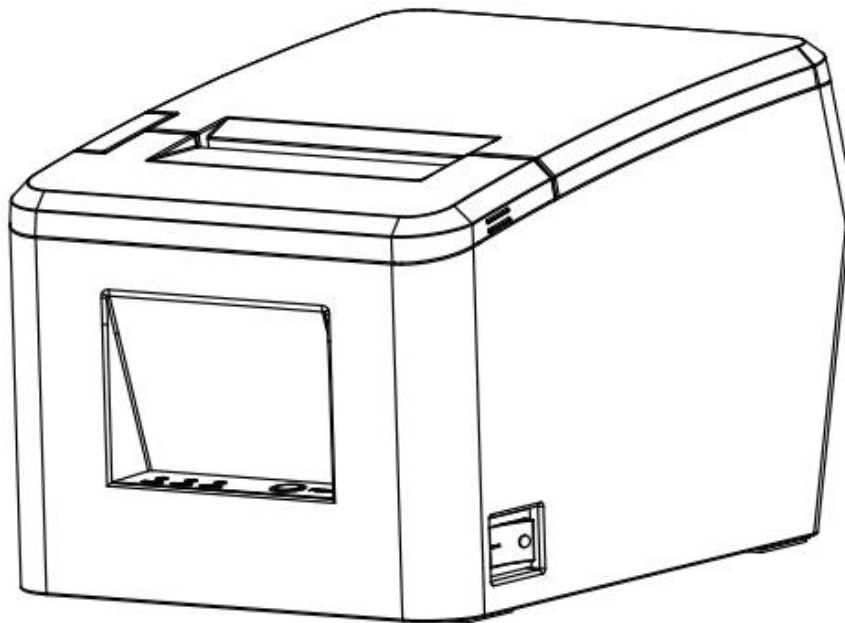

Content

Statement.....	1
Important Safety Instructions.....	2
1 OVERVIEW.....	4
1.1 Introductions.....	4
1.2 The Main Features.....	4
2 GETTING STARTED.....	5
2.1 Packing List.....	5
2.2 Appearance.....	6
2.3 Dimensions.....	7
3 SPECIFICATION.....	8
3.1 Printer Specification.....	8
3.2 Printing Media Specification.....	10
3.2.1 Continuous Thermal Paper Specification.....	10
3.2.2 Notices.....	10
3.3 Printing and Cutting Position.....	11
3.3.1 Printing position.....	11
3.3.2 Cutting Position.....	11
4 INSTALLATION AND USAGE.....	12
4.1 Media Loading.....	12
4.2 Power Connection.....	14
4.3 Cash Drawer Connection.....	15
4.4 LED Indication.....	15
4.5 Print Test.....	16
4.5.1 Print Self-Test.....	16
4.5.2 Printing of Windows Driver Program.....	16

5 INTERFACES.....	17
5.1 USB.....	17
5.2 Cash Drawer Interface.....	17
5.3 Power Port Definition.....	18
5.4 Serial Interface.....	19
5.5 Ethernet Interface.....	19
6 TROUBLESHOOTING.....	20
6.1 Printer Not Working.....	20
6.2 LED Indicator and Beeper Alarm.....	20
6.3 Troubles Occur During Printing.....	20
6.4 Problems Emerge During The Paper Cutting.....	21
6.5 Remove Jammed Paper.....	22
7 PRINTER CLEANING AND MAINTENANCE.....	24
7.1 Cleaning Head.....	24
7.2 Cleaning Sensors, Roller and/or Paper Path.....	24

Statement

Copyright

This manual is printed in 2018.
Printed in China.
1.0 Version.

Warnings



This must be complied with in order to avoid any damage to the human body and to the equipment.



This is showing the important information and tips for the printer operating.

Note

Due to continuous update of product, please take in kind of real machine, such as accessories, programs etc.

Important Safety Instructions

◆ Safety Warning



Warnings: The print head will become very hot during printing; avoid contact with the print head after printing has finished.



Warnings: Do not touch the printer head and connector in case static damage the printer head.

◆ Instructions

Carefully read the installation and operating instructions provided with the printer before starting up your printer.

- 1) Place the printer on a flat and stable surface.
- 2) Leave enough space around printer for operation and maintenance.
- 3) Do not place the printer on or near a heat source.
- 4) Do not use the printer near water. Never spill liquid into the printer.
- 5) Do not expose the printer to high temperatures, direct sunlight or dust.
- 6) Protect the printer from shock, impact and vibration.
- 7) Be certain the power source is within the voltage rating and frequency listed for the printer.
- 8) Switch off the printer power supply when won't use it for a long time.
- 9) Do not place the power cord where it can be stepped on. If the power cord becomes damaged or frayed, replace it immediately.
- 10) To ensure the print quality and reliability, you are suggested to use the recommended paper or the same quality paper.
- 11) Please switch off the power supply when connect/disconnect all the ports or it will cause damage to the printer control circuit.
- 12) Never carry out maintenance or repair work yourself. Always contact a qualified service technician.
- 13) Keep this User Manual in a place which is easily accessible at all times.

◆ Other Precautions

The copyright for this user manual and various other manuals is property of our company. Any copying or conversion into electronic form and saving of this material without the express written permission is strictly prohibited. Use of the information contained in this manual is not subject to any patent liability. This manual has been prepared with utmost care and attention to detail but may contain certain errors and/or omissions. Our company is not legally liable for any damages resulting from the use of the information in this manual. Our company and its affiliates are not legally liable (United States excluded) for any damages, loss, costs, and/or expenses that result from the breakdown, malfunction, and/or misuse of the product due to violation or neglect of the operation and maintenance information and instructions provided by our company, as well as from the unauthorized alteration, repair, and/or modification of the product by the user and/or third party. We are not legally liable for any damages and/or issues resulting from the use of options and/or parts that are not authentic or authorized products.

◆ WEEE (Waste Electrical and Electric Equipment)

This mark shown on the product or its literature indicates that the corresponding item should not be discarded at the end of its working life with other household waste. To prevent possible harm to the environment or human health from uncontrolled waste disposal, please separate marked items from other types of waste and recycle them responsibly to promote the sustained reuse of material resources. Household users should contact either the retailer where they purchased this product, or their local government office for details of where and how they can conduct environmentally safe recycling of such items. Commercial users should contact their suppliers and check the terms and conditions of purchase contracts. This product should not be combined with other commercial waste for disposal.



Caution: This is a Class A product. In a domestic environment this product may cause radio interference in which the user may be required to take adequate measures.

1 OVERVIEW

1.1 Introductions

POS80FE is a thermal receipt printer, featured by high print quality, high print speed, high stability, etc. It can be used in commercial POS system, food industry and occasions which need real-time field print receipts.

POS80FE can connect with other equipment through serial, USB and cash drawer interfaces. And the printer drivers are available for the WINDOWS XP/WINDOWS 7/WINDOWS 8/WINDOWS 10/Linux operating system.

1.2 The Main Features

- 1) Low noise
- 2) High print speed
- 3) Easy paper loading
- 4) Cash drawer interface

2 GETTING STARTED

2.1 Packing List

After receiving your printer, please check for possible shipping damage:

- 1) Inspect the outside of both the box and the printer for possible damage.
- 2) Check whether you have received the following accessories together with the printer, if there is any items missing, please contact your local dealer.



Printer



USB Cable



Power Cord



Power Adapter



Serial Cable

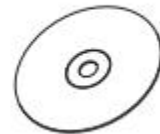

CD



Quick Start Guide

Note:

- ❖ *The power adapter and power cord vary by local and region.*
- ❖ *The packing materials are actually dependent on the order.*

2.2 Appearance

■ Front

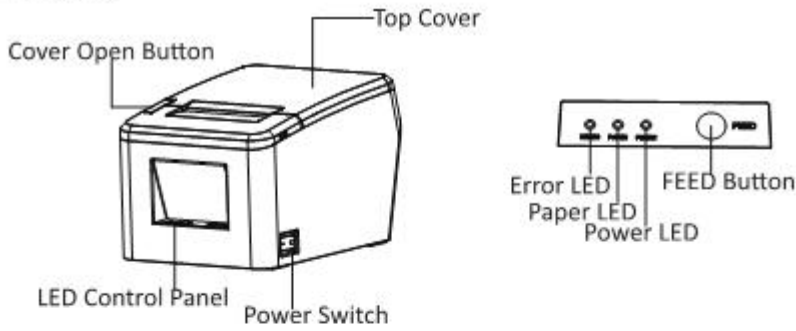

■ Back

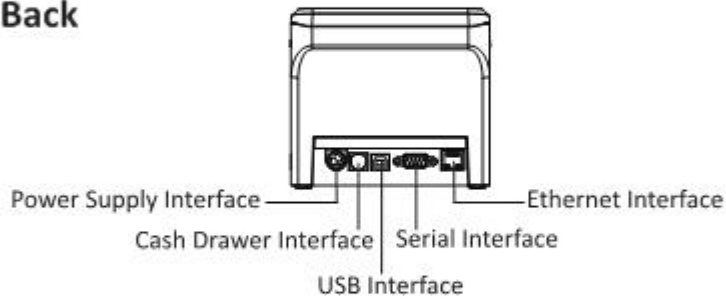

■ Opening Top Cover



2.3 Dimensions

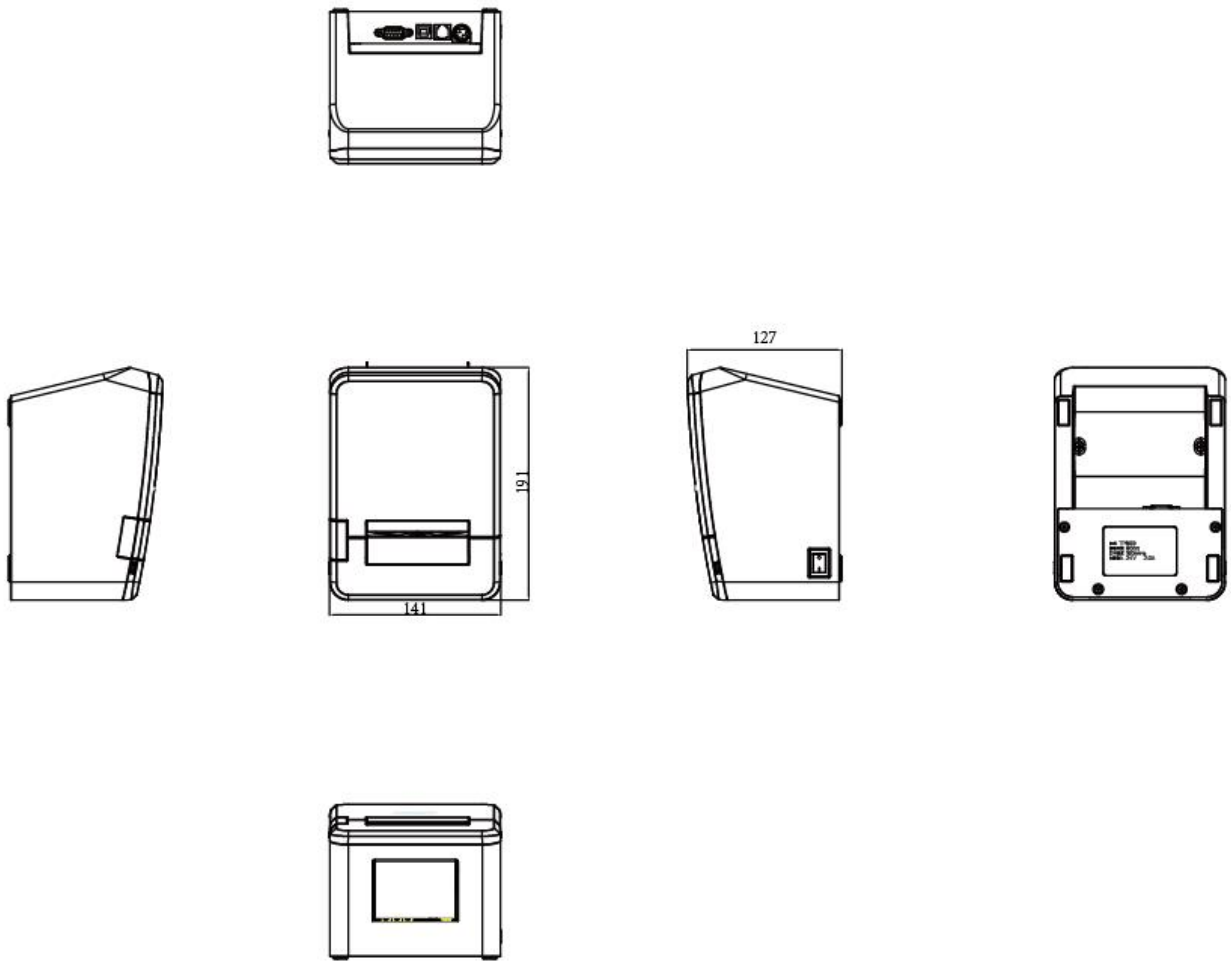

Unit: mm

3 SPECIFICATION

3.1 Printer Specification

Item		Parameter
Printing Parameter	Printing Method	Direct thermal line printing
	Resolution	Default 203 dpi, 180 dpi can be emulated
	Printing Width	72mm (576dots)
	Printing Speed	Max. 230mm/s
	Printing density	Adjustable from degree 1 to degree 4
	Printing Direction	Vertical and horizontal
Interface	Default	Built-in USB, RS232, LAN
	Optional	N/A
auto cutter		Partial Cut
Page mode		YES
Memory	RAM	2MB
	Flash	4MB
Character set	Font	Font A:12*24 Font B:9*17 CHN: 24*24
	Number of Columns	48/64
	Alphanumeric	95
	Code page	PC437/Katakana/PC850/PC860/PC863/PC865/West Europe/Greek/Hebrew/East Europe/Iran/WPC1252/PC866/PC852/PC858/IranII/Latvian/Arabic/PT151,1251/PC737/WPC/1257/Thai Vietnam/PC864/PC1001/(Latvian)/(PC1001)/(PT151,1251)/(WPC1257)/(PC864)/(Vietnam)/(Thai)
Graphics		Support bitmap printing with different density and user defined bitmap printing (Max. 40K for per bitmap, and Max. 256K for total)
Barcode	1D	UPC-A, UPC-E, EAN8, EAN13, CODE39, ITF, CODEBAR, CODE128, CODE93
	2D	QR code
Detection	Sensor	Paper out, Cover Open
Power supply	Input	AC100V-240V 50-60HZ
	Output	DC 24V±5%, 2.0A,
Paper	Paper Loading	Front loading, Up loading, Easy loading
	Paper Type	Standard thermal paper
	Paper Width	79.5±0.5mm
	Paper Thickness	0.056~0.13mm
	Paper Roll Diameter	83mm Max.
Condition	Operating	0~45°C/10~85%RH
	Storage	-20~60°C/10~90%RH
Reliability	TPH Life	150km
	Cutter Life	1,500,000 times
	Motor Life	360 , 000 hours
Emulation		ESC/POS

Packing Information	Dimensions (W*D*H)	TBD
	Accessories	Power adaptor, RS232 cables,CD, Quick Guide, paper roll
Driver		Windows(Win10/POSReady/Win8/Win7/Vista/XP/2000), Linux , OPOS
Certifications		CE/CCC
Eco Features		Paper saving mode, Energy Star qualified

3.2 Printing Media Specification

3.2.1 Continuous Thermal Paper Specification

Paper Type : Standard thermal paper

Paper Width : 79.5±0.5mm

Paper Outer Diameter : Max. 83 mm

Paper Thickness : 0.056~0.13mm

3.2.2 Notices



Notes:

- Please use the recommended thermal paper or same quality paper, otherwise it will influence the printing quality and decrease the thermal printer head life;
- Don't stick the paper on the core of paper roll.
- If the thermal paper is polluted by chemical or oil, the thermal paper heat sensibility decreases, which will influence the printing quality;
- Don't use finger nail or hard articles to touch the surface of thermal paper, otherwise it will cause color fading;
- When the environment temperature is higher than 70°C, the thermal paper color will fade, so pay attention to the influence of temperature, humidity and sunlight.

3.3 Printing and Cutting Position

3.3.1 Printing position

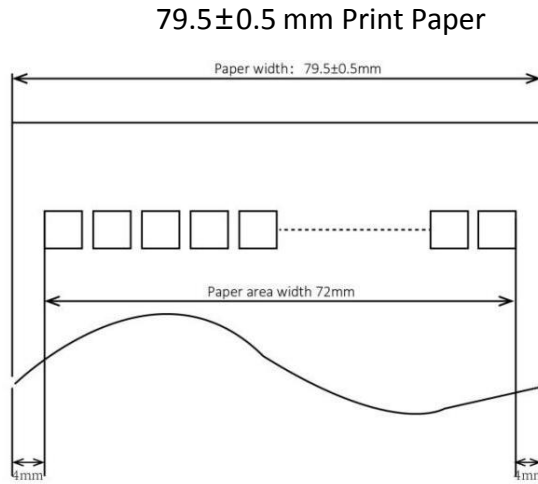

3.3.2 Cutting Position

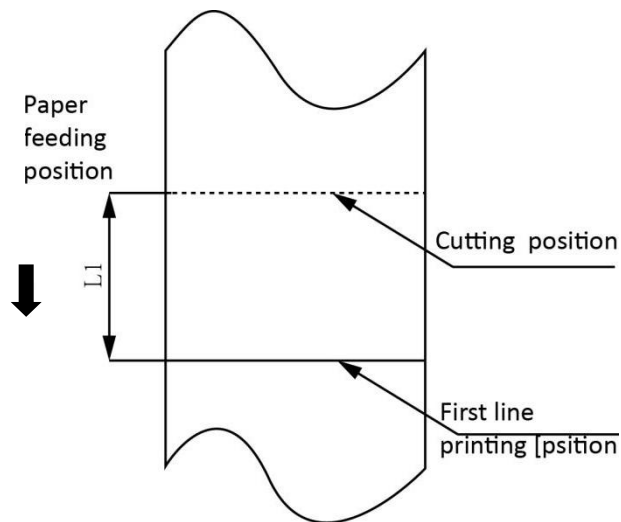

Type	Paper Cutting Position(L1)
POS80FE	8.5mm

4 INSTALLATION AND USAGE

4.1 Media Loading

- 1) Press the cover open button to open the top cover.
- 2) Remove the used roll paper core, if any.

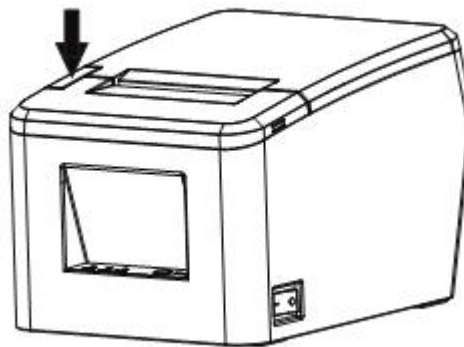

- 3) In the correct direction of the roll paper, insert the paper.

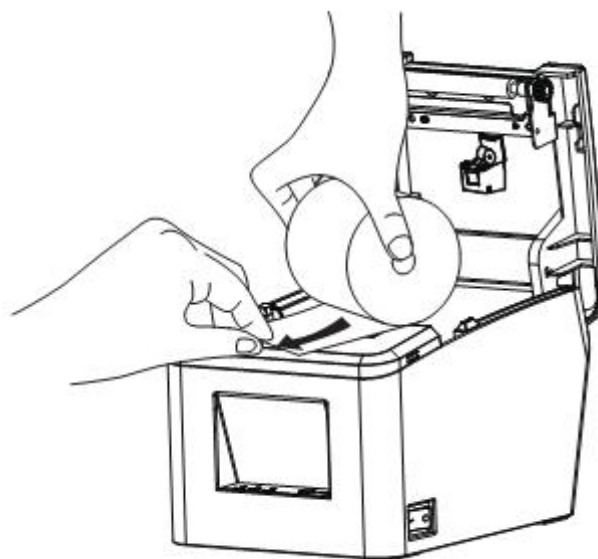

- 4) Pull out some roll paper, and close the top cover.

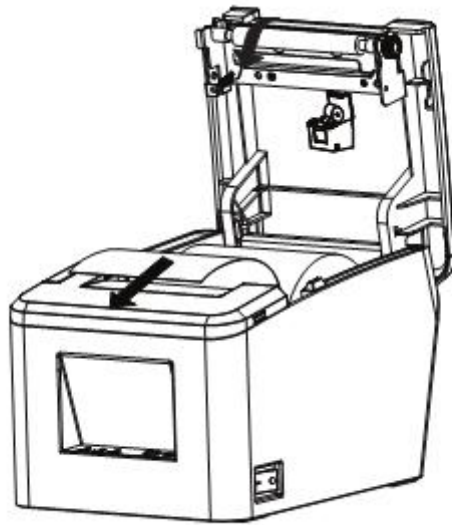

- 5) Tear the extra paper of the printer.

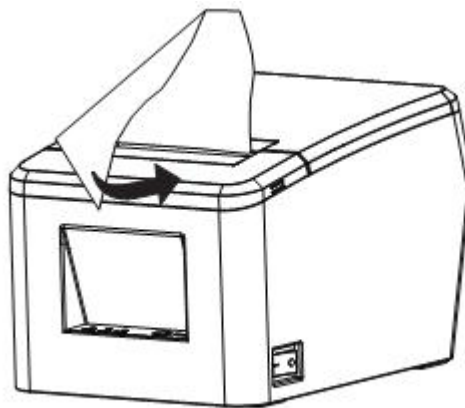

4.2 Power Connection

- 1) Make sure the printer power is turn off .
- 2) Connect power adapter with printer
- 3) Connect power adapter with power cord.
- 4) Plug the other side of power cord into the socket outlet.

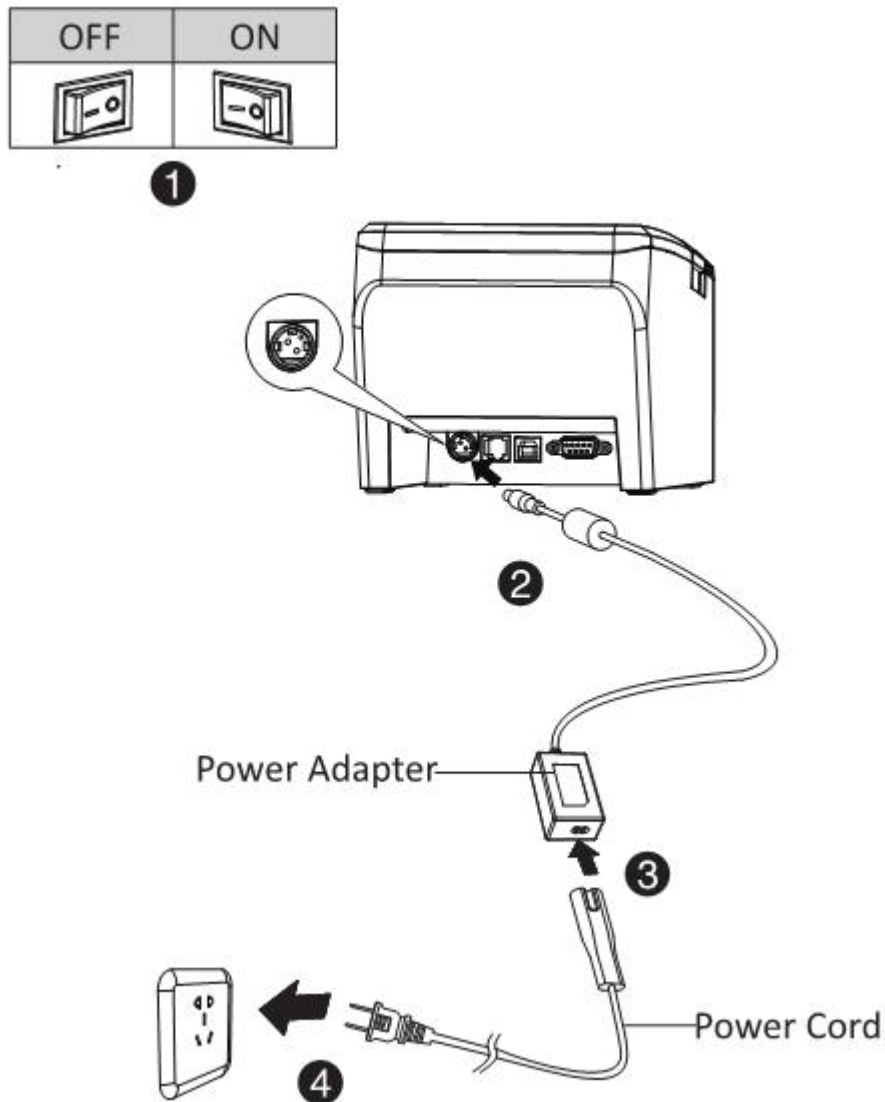

Notes :

- ▶ Please only use the power adapter are recommended by supplied or equivalent products;
- ▶ When disconnecting the power adapter plug, handheld plug connector housing, to avoid the pulling on the cable in force;
- ▶ Avoid drag the power adapter cable, otherwise it will damage the cables, causing fire and shock;
- ▶ Avoid put power adapter around a heating device, otherwise the cable may melt, causing fire and shock;
- ▶ If you do not use the printer in a long time, disconnect the power supply of printer power adapter.

4.3 Cash Drawer Connection

- 1) Make sure the printer's power switch is turned off;
- 2) Connect the cash drawer cable into the cash drawer interface on the rear side of the printer.



Warning:

Cash drawer interface can only be connected to a voltage of 24V cash drawer device (can't connect to the phone line, etc.)

4.4 LED Indication

Function specification of indicated light and beeper.

Name	Status	Specification
POWER LED (Green)	ON	The printer work well.
	OFF	The printer powers off.
ERROR LED (Red)	Flash	The printer in an error state
	OFF	The printer in an normal state
PAPER LED (Red)	ON	The printer in paper out state
	OFF	The printer in an normal state

Description	POWER LED	ERROR LED	PAPER LED	Beeper
Cover Open	ON	ON	ON	"Beep ,Beep--,Beep"
No Paper	ON	ON	ON	"Beep, Beep, Beep"
Cutter Jam	ON	Flash	OFF	"Beep—, Beep—"



Notes:

The printer use a thermistor to detect the temperature of the print head. If the temperature of print head is more than 65° C, printer will send a warning. If the temperature of print head is more than 80° C, printer will stop working until the temperature is less than 60° C.

4.5 Print Test

4.5.1 Print Self-Test

The self-test checks the printer's current settings, status and whether the printer has any problem.

- (1) Make sure the power is connecting and paper is loading properly.
- (2) Make sure the printer is off and top cover closes properly.
- (3) Pressing the paper feed button and power button simultaneously turns the printer on. The printer is ready to receive data as soon as it completes the self-test.

4.5.2 Printing of Windows Driver Program

- (1) Install the Windows Driver program. (Please refer to the Windows Driver Manual)
- (2) Please set the "Ports" as the type you use.
- (3) Use the Windows Driver Program to print out the "Print Test Page".

5 INTERFACES

POS80FE supports serial interface, ethernet interface, cash drawer interface and USB interface.

5.1 USB

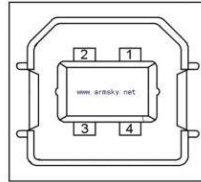

Figure 5-1

PIN	SIGNAL NAME
1	VBUS
2	D-
3	D+
4	GND

5.2 Cash Drawer Interface

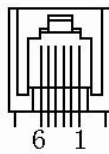

Figure 5-2

PIN NO.	Signal Name
1	FG
2	Drawer 1
3	DRSW
4	VDR
5	Drawer 2
6	GND

Electrical characteristics

- Driving voltage : DC 24V
- Driving current : Maximum 0.8 A (In 510 ms)

Detection signal for drawer status : “L” = 0 ~ 0.5 V “H” = 3 ~ 5 V

5.3 Power Port Definition

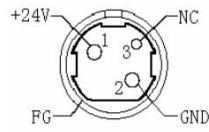

Figure 5.3

PIN NO.	Signal Name
1	+24V
2	GND
3	N.C
SHELL	F.G



Note :

- *Strictly prohibit unplug the cable while the printer is power on.*
- *When arranging the line of communication, you have to avoid paralleling with the strong current.*
- *you have to use the shielded communication line.*

5.4 Serial Interface

Printer POS80FE serial interface is compatible with RS-232 standard, with 9 pin socket.

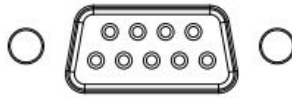
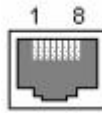

Figure 5.4

PIN NO.	Signal Name
1	-
2	TXD
3	RXD
4	-
5	GND
6	DTR
7	-
8	RTS
9	-

5.5 Ethernet Interface



PIN No.	Signal
1	TX+
2	TX-
3	RX+
4	n/c
5	n/c
6	RX-
7	n/c
8	n/c

NOTE: Ethernet interface can only be connected to an such interface of end device which has been isolated .

6 TROUBLESHOOTING

Your printer is very reliable, but occasionally problems may occur. This chapter provides information on some common problems you may encounter and how to solve them. If you encounter problems that you can not resolve, contact your dealer for assistance.

6.1 Printer Not Working

Problem Description	Probable Reason	Solution
LED not light, printer not working	Printer no power	Connecting the power supply
	Printer not on	Turn on the printer
	Circuit board broken	Contact with the dealer

6.2 LED Indicator and Beeper Alarm

Problem Description	Probable Reason	Solution
Error LED always on and beeper alarms	Printer Cover open	Close the printer cover
Paper LED and Error LED always on and beeper alarms	Paper end	Reload the roll paper
Error LED blinks and beeper alarms	Thermal print head overheated	Turn the printer off and resume when it cools
	overvoltage	Print with specified voltage
	Low-voltage	Print with specified voltage

6.3 Troubles Occur During Printing

Problem Description	Probable Reason	Solution
Blurred printing or spot	Incorrect roll paper installation	Check if the roll paper is installed
	Unqualified roll paper	Use recommended thermal roll paper
	Dirty thermal head or print roller	Clean the thermal head or print roller
	Low print density	Increase the print density level
Paper Jam	Paper strike	Open the printer cover, check the paper path and remove jammed paper
Vertical print words missing	Dirty thermal head or print roller	Clean the thermal head or print roller
	Thermal head damaged	Contact your dealer for assistance

6.4 Problems Emerge During The Paper Cutting

Problem Description	Probable Reason	Resolution
Cutter jam, the movable cutter cannot back	Cutter abrasion, insufficient cutting	Replace the cutter
	Worm gear and worm wheel abrasion	Replace the worm gear and worm wheel
	Motor burnt	Replace the motor
	Paper scraps	Clean the paper scraps on the transmission system
Insufficient cutting	Cutter edge abrasion, paper too thick	Replace the cutter
Paper jam	Thermal printer head over heat	Reduce the density of printing
	Driving too fast	Reduce the printer speed to the limit of thermal printer head
	Wrong paper feeding position	Put the paper parallel with the paper mount and insert into the space between platen roller and the thermal printer head.

NOTE: The density of setting, please refer to "Utility Tool Manual"

6.5 Remove Jammed Paper

- 1) When a paper jammed, do not press the cover open button to avoid damaging the blade.

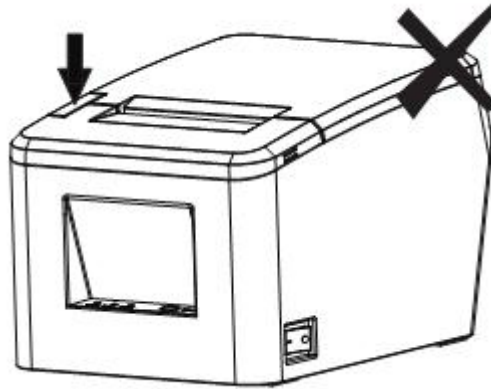

- 2) Fix the printer by one hand and press either side of the convex bars by the other hand. Push up and open the front cover.

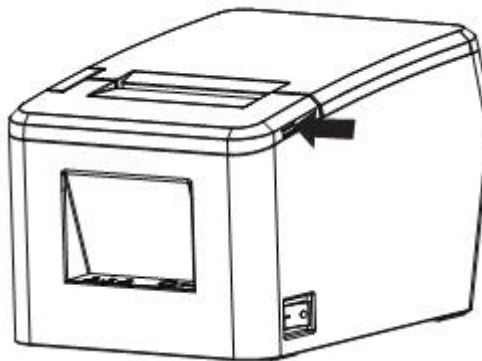

3) Please rotate the gear until the blade returns to its normal position, as shown in Figure 2.

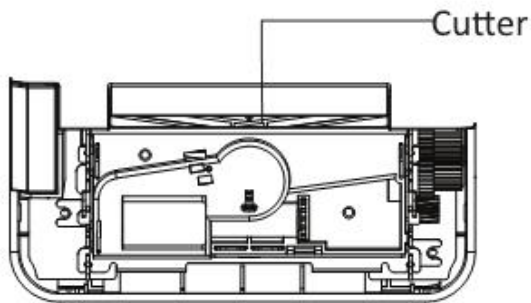
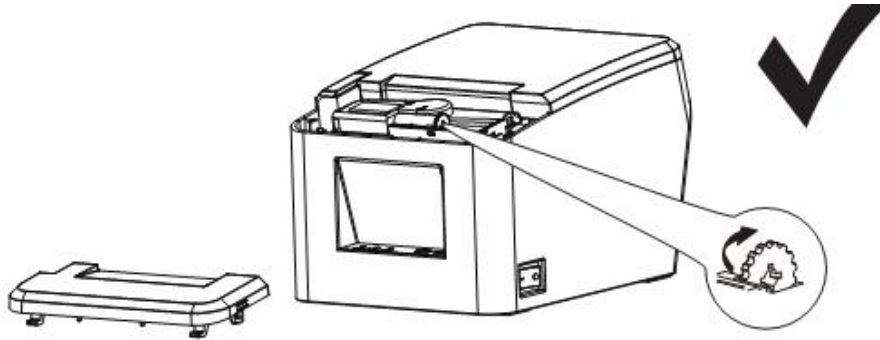

When cutter jammed, the cutter does not retreat back and can be seen.

Figure 1

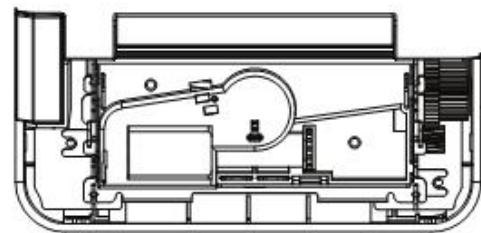

Cutter retreats back totally and cannot be seen.

Figure 2

7 PRINTER CLEANING AND MAINTENANCE

Print quality might be degraded by dust, foreign substance, adhesive substance, or other pollution materials stuck in the printer head or inside the printer.

When dirty, clean the print head as follows:

※ CAUTION

- Make sure to turn off the printer prior to cleaning.
- As the print head gets hot during printing, intending to clean the print head, turn the printer off and wait approximately 2~3 minute before commencement.
- When cleaning the print head, take care not to touch the heated portion of the print head. Print Head is susceptible to damage from static electricity, etc.
- Take care not to allow the print head become scratched and/or damaged in any way.

7.1 Cleaning Head

- 1) Open the Printer Cover and then use the cleaning pen to clean the head in the direction from the center of the head to the edges.
- 2) After cleaning the head, do not use the printer until the alcohol used for cleaning evaporates completely (1~2 min) and the printer has completely dried.

7.2 Cleaning Sensors, Roller and/or Paper Path

- 1) Open the printer cover and then remove the paper.
- 2) Remove any dust or foreign substance using dry cloth or cotton swab.
- 3) Soak the cloth or cotton swab in alcohol for medical use and use it to remove adhesive foreign substances or other pollution materials.
- 4) After cleaning the parts, do not use the printer until the alcohol evaporates completely (1~2 min) and the printer has completely dried.

※ Clean the parts whenever print quality or paper detection degraded.